



EN - english

Instructions for installation and operation

Compressed air refrigeration dryer

SPRPRC 200Z - 500Z 3ph

Dear customer,

Thank you for deciding in favour of the SPRPRC 200Z - 500Z compressed-air refrigeration dryer. Please read these installation and operating instructions carefully before mounting and starting up the SPRPRC 200Z - 500Z and follow our directions. Perfect functioning of the SPRPRC 200Z - 500Z and thus reliable compressed-air drying can only be guaranteed when the provisions and notes stipulated here are strictly adhered to.

Contents

1	Name plate	5
2	Safety instructions	5
2.1	Safety pictograms in accordance with DIN 4844	6
2.2	Signal words in accordance with ANSI	8
2.3	Overview of the safety instructions	8
3	Proper use	11
4	Exclusion from a field of application	11
5	Operating instructions in accordance with the 2014/68/EU Pressure Equipment Directive	11
6	Transport	12
7	Storage	12
8	Installation	12
8.1	Place of installation	12
8.2	Installation plan	13
8.3	Correction factors	14
8.4	Connection to the compressed-air system	15
8.5	Electrical connections	15
8.6	Condensate drain	16
9	Start-up	17
9.1	Preliminary stages	17
9.2	Initial start-up	17
9.3	Shut down and restart	18
10	Technical data	19
10.1	Technical data SPRPRC 200Z - 500Z 3phase 3/460/60	19
11	Technical description	20
11.1	Control panel	20
11.2	Functional description	20
11.3	Flow chart	21
11.4	Refrigerating compressor	22
11.5	Condenser	22
11.6	Filter dryer	22
11.7	Capillary tube	22
11.8	Aluminium heat exchanger	22
11.9	Hot-gas bypass valve	22
11.10	Refrigerant pressure switches LPS – HPS – PV	23
11.11	Compressor crankcase heater	23
11.12	DMC51 electronic control unit	24
11.12.1	Switching the dryer on	24
11.12.2	Switching the dryer off	24
11.12.3	Indication of the operating parameters	24
11.12.4	Indication of a service warning	25
11.12.5	Indication of an alarm	25
11.12.6	Operation of the potential-free failure/alarm contact	26
11.12.7	How to change operating parameters – SETUP menu	26
11.13	Electronically level-controlled ZL Drain	26
12	Maintenance, troubleshooting, spare parts and dismantling	27
12.1	Checks and maintenance	27
12.2	Troubleshooting	28
12.3	Recommended spare parts	33
12.4	Maintenance works at the refrigeration cycle	34
12.5	Dismantling the dryer	34
13	Appendices	35
13.1	Dryer dimensions	35
13.1.1	Dryer dimensions SPRPRC 200Z-250Z 3phase	35
13.1.2	Dryer dimensions SPRPRC 300Z-350Z 3phase	36
13.1.3	Dryer dimensions SPRPRC 400Z-500Z 3phase	37
13.2	Exploded diagrams	38
13.2.1	Components of the exploded diagrams	38

13.2.2	Exploded diagram SPRPRC 200Z-250Z 3phase / AC	39
13.2.3	Exploded diagram SPRPRC 300Z-350Z 3phase / AC	40
13.2.4	Exploded diagram SPRPRC 400Z-500Z 3phase / AC	41
13.3	Electric diagrams	42
13.3.1	Electric diagrams – list of components	42
13.3.2	Electric diagram SPRPRC 200Z - 500Z 3phase Sheet 1/3	43
13.3.3	Electric diagram SPRPRC 200Z - 500Z 3phase Sheet 2/3	44
13.3.4	Electric diagram SPRPRC 200Z - 500Z 3phase Sheet 3/3	45

1 Name plate

The name plate is on the back of the dryer and comprises all primary data of the device. Always refer to these when contacting the manufacturer or the sales department.

All guarantee claims will expire in the event that the name plate is modified or removed.

2 Safety instructions



Please check whether or not these instructions correspond to the device type.

Please adhere to all advice given in these operating instructions. They include essential information which must be observed during installation, operation and maintenance. Therefore, it must be ensured that these operating instructions are read by the fitter and the responsible operator / certified skilled personnel prior to installation, start-up and maintenance.

The operating instructions must be accessible at all times at the place of application of the SPRPRC 200Z - 500Z compressed-air refrigeration dryer.

In addition to these operating instructions, local and national regulations need to be observed, where required .

Ensure that operation of the SPRPRC 200Z - 500Z compressed-air refrigeration dryer only takes place within the permissible limit values indicated on the name plate. Any deviation from these limit values involves a risk for persons and for the material, and may result in malfunction or a breakdown.

After installing the device correctly and in accordance with the instructions in this manual, the dryer is ready to operate, further settings are not required. Operation is fully automatic and maintenance is limited to several examinations and cleaning measures which are described in the following chapters.

This manual must be available at all times for future reference and is a constituent part of the dryer.

If you have any queries regarding these installation and operating instructions, please contact Sullivan Palatek

2.1 Safety pictograms in accordance with DIN 4844



Observe operating instructions



General danger symbol



Supply voltage



Danger: component or system under pressure



Hot surfaces



Non-breathable air



Do not use water to extinguish the fire



Do not operate with open cover (housing)



Maintenance works or controlling measures must only be carried out by qualified personnel¹



Do not smoke



Note



Connection point compressed-air inlet



Connection point compressed-air outlet



Connection point condensate drain

¹ Certified skilled personnel are persons who are authorised by the manufacturer, with experience and technical training, who are well-grounded in the respective provisions and laws and capable of carrying out the required works and of identifying and avoiding any risks during the machine transport, installation, operation and maintenance. Qualified and authorised operators are persons who are instructed by the manufacturer regarding the handling of the refrigeration system, with experience and technical training, and who are well-grounded in the respective provisions and laws.



Works can be carried out by the operator of the plant, provided that they are skilled accordingly².

NOTE: Text that contains important specifications to be considered – does not refer to safety precautions.



The device was carefully designed with particular attention paid to environmental protection:

- CFC-free refrigerants
- CFC-free insulation material
- Energy-saving design
- Limited acoustic emissions
- Dryer and packaging comprise reusable materials

This symbol advises the user to observe the environmental aspects and comply with the recommendations connected with this symbol.

² Certified skilled personnel are persons who are authorised by the manufacturer, with experience and technical training, who are well-grounded in the respective provisions and laws and capable of carrying out the required works and of identifying and avoiding any risks during the machine transport, installation, operation and maintenance. Qualified and authorised operators are persons who are instructed by the manufacturer regarding the handling of the refrigeration system, with experience and technical training, and who are well-grounded in the respective provisions and laws.

2.2 Signal words in accordance with ANSI

Danger!	Imminent hazard Consequences of non-observance: serious injury or death
Warning!	Potential hazard Consequences of non-observance: possible serious injury or death
Caution!	Imminent hazard Consequences of non-observance: possible injury or property damage
Notice!	Potential hazard Consequences of non-observance: possible injury or property damage
Important!	Additional advice, info, hints Consequences of non-observance: disadvantages during operation and maintenance, no danger

2.3 Overview of the safety instructions



Certified skilled personnel

Installation works must exclusively be carried out by authorised and qualified skilled personnel. Prior to undertaking any measures on the SPRPRC 200Z - 500Z compressed-air refrigeration dryer, the certified skilled personnel shall read up on the device by carefully studying the operating instructions. The operator is responsible for the adherence to these provisions. The respective directives in force apply to the qualification and expertise of the certified skilled personnel.

For safe operation, the device must only be installed and operated in accordance with the indications in the operating instructions. In addition, the national and operational statutory provisions and safety regulations, as well as the accident prevention regulations required for the respective case of application, need to be observed during employment. This applies accordingly when accessories are used.



Danger!

Compressed air!

Risk of serious injury or death through contact with quickly or suddenly escaping compressed air or through bursting and/or unsecured plant components.

Compressed air is a highly dangerous energy source.

Never work on the dryer when the system is under pressure.

Never direct the compressed-air outlet or condensate drain hoses at persons.

The user is responsible for the proper installation of the dryer. Non-observance of the instructions in the "Installation" chapter leads to the expiration of the guarantee. Improper installation may result in dangerous situations for the personnel and/or the device.



Danger!

Supply voltage!

Contact with non-insulated parts carrying supply voltage involves the risk of an electric shock resulting in injuries and death.

Only qualified and skilled personnel are authorised to run electrically-operated devices. Prior to undertaking maintenance measures at the device, the following requirements must be met:

Make sure that the power supply is switched off and that the device is off and marked for maintenance measures. Please also ensure that the power supply cannot be re-established during the works.



Caution!

Refrigerant!

The compressed-air refrigeration dryer uses HFC-containing refrigerants as a coolant.

Please observe the corresponding paragraph entitled "Maintenance works at the refrigeration cycle".

**Warning!****Refrigerant leak!**

A refrigerant leak involves the danger of serious injury and damage to the environment.



The SPRPRC 200Z - 500Z compressed-air refrigeration dryer contains fluorinated greenhouse gas/refrigerant.

Installation, repair and maintenance works at the refrigeration system must only be carried out by certified skilled personnel (specialists). A certification in accordance with EC regulation 303/2008 must be available.



The requirements of the EC 842/2006 directive must be met under all circumstances.

Please refer to the indications on the name plate as regards the type and amount of refrigerant.



Comply with the following protective measures and rules of conduct:

- **Storage:** Keep the container tightly closed. Keep it in a cool and dry place. Protect it against heat and direct sunlight. Keep it away from ignition sources.
- **Handling:** Take measures against electrostatic charging. Ensure good ventilation/suction at the workplace. Check fittings, connections and ducts for tightness. Do not inhale the gas. Avoid contact with the eyes or the skin.
- Prior to carrying out works on refrigerant-carrying parts, remove the refrigerant to such an extent that safe working is possible.
- Do not eat, drink or smoke during work. Keep out of the reach of children.
- **Breathing protection:** ambient-air-independent respirator (at high concentrations).
- **Eye protection:** sealing goggles.
- **Hand protection:** protective gloves (e.g. made of leather).
- **Personal protection:** protective clothing.
- **Skin protection:** use protective cream.



In addition, the safety data sheet for the refrigerant needs to be observed!

**Caution!****Hot surfaces!**

During operation, several components can reach surface temperatures of more than 140°F (60°C). There is the risk of burns.

All components concerned are installed inside of the closed housing. The housing must only be opened by certified skilled personnel³.

**Caution!****Improper use!**

The device is intended for the separation of water in compressed air. The dried air cannot be used for breathing-air purposes and is not suitable for the direct contact with food.

This dryer is not suitable for the treatment of contaminated air or of air containing solids.

³ Certified skilled personnel are persons who are authorised by the manufacturer, with experience and technical training, who are well-grounded in the respective provisions and laws and capable of carrying out the required works and of identifying and avoiding any risks during the machine transport, installation, operation and maintenance. Qualified and authorised operators are persons who are instructed by the manufacturer regarding the handling of the refrigeration system, with experience and technical training, and who are well-grounded in the respective provisions and laws.



Note!

Contaminated intake air!

In the event that the intake air is strongly contaminated (ISO 8573.1 class 3.-3 or poorer quality), we recommend the additional installation of a prefilter (e.g. ProPure), to avoid clogging of the heat exchanger.



Caution!

Heating-up through fire!

In the event of a heating-up through fire, the containers and pipes of the refrigerant system can burst.



In this case, please proceed as follows:

Switch off the refrigeration plant.

Switch off the mechanical ventilation of the machinery compartment.

Use ambient-air-independent respirators.

Containers and plants which are filled with refrigerant can burst violently in the event of fire.

The refrigerants themselves are incombustible, but they are degraded to very toxic products at high temperatures.

Remove the container/plant from the fire zone, as there is the risk of bursting!

Cool down containers and bottles via a directed water jet from a safe position.

In the event of fire, please use an approved fire extinguisher. Water is not a suitable agent to extinguish an electrical fire.

This must only be carried out by persons who are trained and informed about the hazards emanating from the product.



Caution!

Unauthorised intervention!

Unauthorised interventions may endanger persons and plants and lead to malfunction.

Unauthorised interventions, modification and abuse of the pressure devices are prohibited.

The removal of sealings and leadings at safety devices is prohibited.

Operators of the devices must observe the local and national pressure equipment regulations in the country of installation.



Note!

Ambient conditions!

In the event that the dryer is not installed under suitable ambient conditions, the ability of the device to condense refrigerant gas is impaired. This can result in a higher load of the refrigerating compressor, and in a loss of efficiency and performance of the dryer.

This in turn leads to overheated condenser fan motors, to malfunction of electric components and to a breakdown of the dryer. Failures of this type will affect warranty considerations.

Do not install the dryer in an environment in which chemicals with a corrosive effect, explosive gases, toxic gases, evaporation heat, high ambient temperatures or extreme dust and dirt can be found.

3 Proper use

This dryer was designed, manufactured and tested to separate the moisture which normally exists in compressed air. Any other use is considered improper.

The manufacturer shall not be liable for problems occurring as a consequence of improper use. The user alone is responsible for any damage resulting from that.

Furthermore, the correct use includes the compliance with the installation instructions, in particular in respect of:

- The voltage and frequency of the main voltage supply.
- The pressure, temperature and flow rate of the inlet air.
- The ambient temperature.

When delivered, the dryer is tested and fully assembled. The customer only needs to connect the device to the system in accordance with the instructions in the following chapters.

4 Exclusion from a field of application



Note!
Improper use!



The device is intended for the separation of water in compressed air. The dried air cannot be used for breathing-air purposes and is not suitable for the direct contact with food.

This dryer is not suitable for the treatment of contaminated air or of air containing solids.

5 Operating instructions in accordance with the 2014/68/EU Pressure Equipment Directive

The SPRPRC 200Z - 500Z compressed-air refrigeration dryer contains pressure equipment in the sense of the 2014/68/EU Pressure Equipment Directive. Therefore, the entire plant needs to be registered with the supervisory authority if required in accordance with the local regulations.

For the examination prior to the start-up and for periodic inspections, the national regulations need to be observed, such as the industrial safety regulation in the Federal Republic of Germany. In countries outside the EU, the respective regulations in force there need to be adhered to.

The proper use of pressure devices is the basic requirement for safe operation. As regards pressure devices, the following points need to be observed:

- The SPRPRC 200Z - 500Z compressed-air refrigeration dryer must only be employed within the pressure and temperature range limits indicated by the manufacturer on the name plate.
- No welding must be carried out on the pressure parts.
- The SPRPRC 200Z - 500Z compressed-air refrigeration dryer must neither be installed in insufficiently ventilated rooms nor near heat sources or inflammable substances.
- To avoid fractures resulting from material fatigue, the refrigeration dryer should not be exposed to vibrations during operation.
- The maximum operating pressure indicated by the manufacturer on the name plate must not be exceeded. It is the installer's responsibility to install the appropriate safety and control devices. Prior to the start-up of the SPRPRC 200Z - 500Z compressed-air refrigeration dryer, the connected pressure generator (compressor etc.) must be set to the max. permissible operating pressure. The integrated safeguard needs to be checked by an approved inspection agency.
- The documents related to the SPRPRC 200Z - 500Z compressed-air refrigeration dryer (manual, operating instructions, manufacturer's declaration etc.) must be kept safe for future reference.
- No objects whatsoever must be installed at or placed on the SPRPRC 200Z - 500Z compressed-air refrigeration dryer and the connecting lines.
- Installation of the plant in frost-free places only.
- Operation of the plant is only permissible with fully closed and intact housing and cover panels. Operation of the plant with damaged housing/cover panels is prohibited.

6 Transport

Check the packaging for visible loss or damage. If no visible damage can be ascertained, place the unit in close proximity to the place of installation and unpack the device.

During this procedure, the dryer must always remain in an upright position. The components may be damaged when the unit is tilted or turned upside down.

Store the device in a dry environment and do not expose it to extreme weather conditions.

Handle with care. Strong shocks can cause irreparable damage.

7 Storage

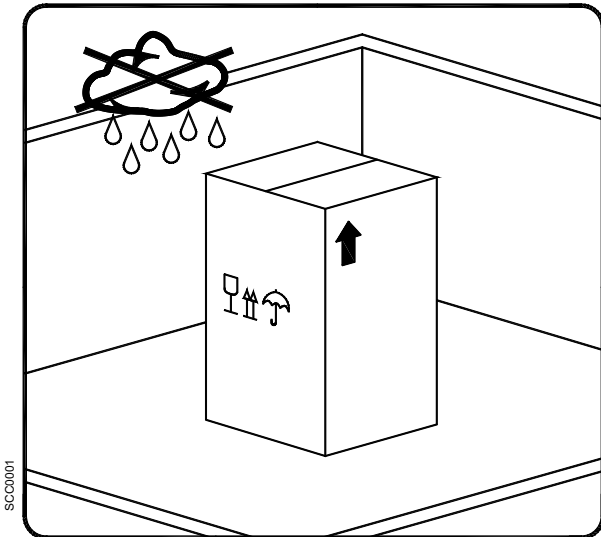

Keep the device away from extreme weather conditions even when packaged.

Keep the dryer in an upright position, also while it is stored. Tilting the device or turning it upside down can cause irreparable damage to some components.

When the dryer is not in use, it can be stored in its packaging in a dust-free and protected place at a temperature of 34 ... 122°F (1 ... 50°C) and at a specific humidity of max. 90%. If the storage period exceeds 12 months, you should contact the manufacturer.



The packaging material is recyclable. Dispose of the material in accordance with the directives and provisions in force in the country of destination

8 Installation

8.1 Place of installation



Note!

Ambient conditions!

In the event that the dryer is not installed under suitable ambient conditions, the ability of the device to condense refrigerant gas is impaired. This can result in a higher load of the refrigerating compressor, and in a loss of efficiency and performance of the dryer.

This in turn leads to overheated condenser fan motors, to malfunction of electric components and to a breakdown of the dryer. Failures of this type will affect warranty considerations.

Do not install the dryer in an environment in which chemicals with a corrosive effect, explosive gases, toxic gases, evaporation heat, high ambient temperatures or extreme dust and dirt can be found.

Minimum installation requirements:

- Choose an area which is clean and dry, free from dust and protected against atmospheric disturbances.
- The load-bearing zone must be even, horizontal and able to bear the weight of the dryer.
- Minimum ambient temperature +34°F (+1°C).
- Maximum ambient temperature +122°F (+50°C).
- Ensure a proper cooling air replacement.
- Allow a sufficient clearance on each side of the dryer for proper ventilation and to facilitate maintenance operations. The dryer does not require attachment to the floor surface.



Do not obstruct the ventilation grille (not even partially).

Prevent any recirculation of the outgoing cooling air.

Protect the dryer against draughts.

8.2 Installation plan

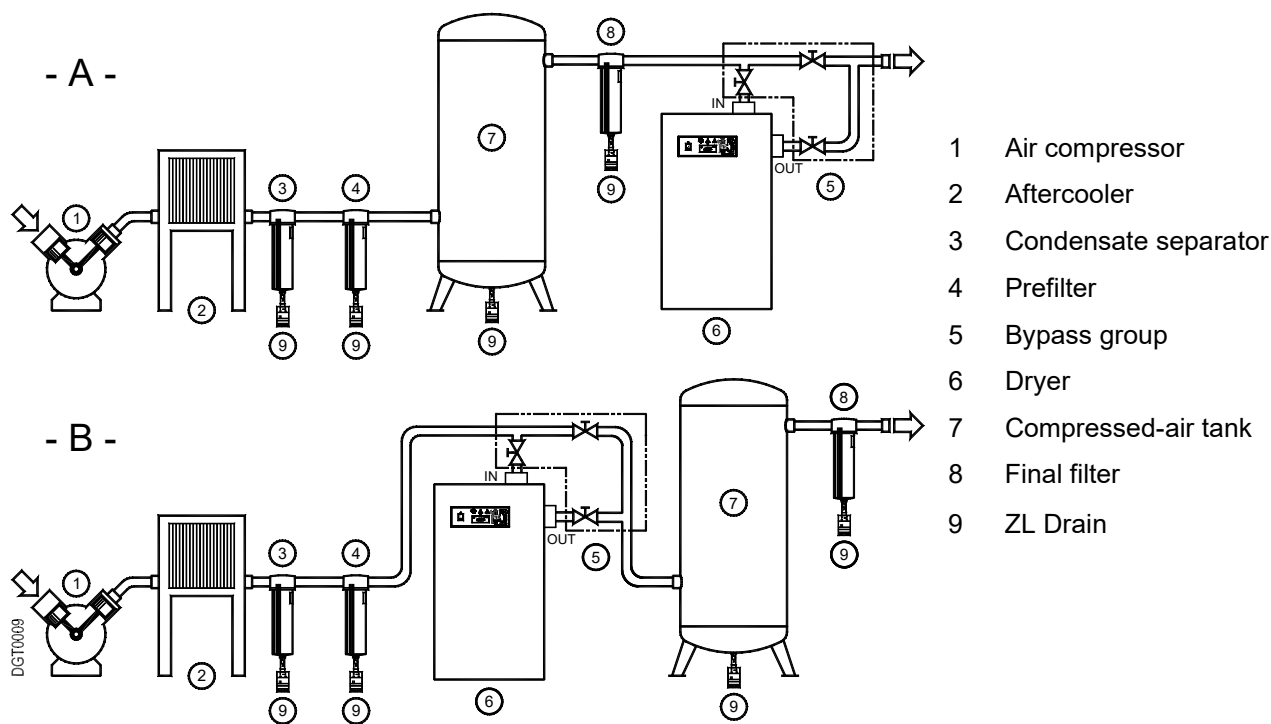

Installation **type A** is recommended when the total consumption corresponds to the throughput rate of the compressor. Installation **type B** is recommended when the air consumption constantly varies, with peak values which considerably exceed the throughput rate of the compressor. The storage capacity of the tank must be dimensioned in such a way that a possible short-term high air demand (peak air consumption) can be compensated.



Do not obstruct the ventilation grille (not even partially).

Prevent any recirculation of the outgoing cooling air.
 Protect the dryer against draughts.



Note!
Contaminated intake air!

In the event that the intake air is strongly contaminated (ISO 8573.1 class 3.-3 or poorer quality), we recommend the additional installation of a prefilter (e.g. ProPure), to avoid clogging of the heat exchanger.

8.3 Correction factors

Correction factor for operating pressure modifications:									
Inlet air pressure	psig	60	80	100	120	140	160	180	203
	barg	4	5.5	7	8	10	11	12	14
Factor (F1)		0.79	0.91	1.00	1.07	1.13	1.18	1.23	1.27

Correction factor for ambient temperature modifications :									
Ambient temperature	°F	≤ 80	90	95	100	105	110	115	122
	°C	≤ 27	32	35	38	40	43	45	50
Factor (F2)		1.11	1.09	1.06	1.00	0.94	0.87	0.78	0.69

Correction factor for inlet air temperature modifications:									
Air temperature	°F	≤ 90	100	110	122	130	140	150	158
	°C	≤ 32	38	43	50	55	60	65	70
Factor (F3)		1.16	1.00	0.82	0.68	0.61	0.52	0.45	0.40

Correction factor for DewPoint modifications:									
DewPoint	°F	38	41	45	50				
	°C	3	5	7	10				
Factor (F4)		1.00	1.08	1.20	1.36				

Calculation of the actual air throughput:

Actual air throughput = air throughput acc. to planning x factor (F1) x factor (F2) x factor (F3) x factor (F4)

Example:

The **SPRPRC 250Z** has a planned nominal capacity of 250 scfm (425 m³/h). The highest achievable air mass under the following operating conditions is:

- Air inlet pressure = 120 psig (8 barg) ⇒ Factor (F1) = 1.07
- Ambient temperature = 115°F (45°C) ⇒ Factor (F2) = 0.78
- Air inlet temperature = 122°F (50°C) ⇒ Factor (F3) = 0.68
- Pressure dew point = 50°F (10°C) ⇒ Factor (F4) = 1.36

Every function parameter corresponds to a numerical factor which, multiplied by the planned nominal capacity, determines the following:

Actual air throughput = 250 x 1.07 x 0.78 x 0.68 x 1.36 = 193 scfm (328 m³/h)

193 scfm (328 m³/h) is the maximum flow rate of the dryer under the aforementioned operating conditions.

Selection of the best suitable model in accordance with the operating conditions:

Air throughput acc. to planning = $\frac{\text{Requ. air throughput}}{\text{Factor (F1) x Factor (F2) x Factor (F3) x Factor (F4)}}$

Example:

The following operating parameters are known:

- Required air mass = 180 scfm (306 m³/h) ⇒ Factor (F1) = 1.07
- Air inlet pressure = 120 psig (8 barg) ⇒ Factor (F2) = 0.78
- Ambient temperature = 115°F (45°C) ⇒ Factor (F3) = 0.68
- Air inlet temperature = 122°F (50°C) ⇒ Factor (F4) = 1.36
- Pressure dew point = 50°F (10°C)

To find out the correct dryer version, the required air mass must be divided by the correction factors of the parameters indicated above:

Air throughput acc. to planning = $\frac{180}{1.07 \times 0.78 \times 0.68 \times 1.36} = 233 \text{ scfm (396 m³/h)}$

The suitable model for these requirements is **SPRPRC 250Z** (with a spec. nominal capacity of **250 scfm [425 m³/h]**).

8.4 Connection to the compressed-air system



Danger! **Compressed air!**

All works must only be carried out by qualified skilled personnel.
Never work on compressed-air systems which are under pressure.



The operator or the user must ensure that the dryer is never operated with a pressure exceeding the maximum pressure value indicated on the name plate.
Exceeding the maximum operating pressure can be dangerous for the operator but also for the device.

The air temperature and the air flow at the inlet of the dryer must lie within the limit values indicated on the name plate. The connecting lines must be free from dust, iron rust, shards and other contaminations and correspond to the flow rate of the dryer. Should air with a very high temperature be treated, the installation of an aftercooler may be necessary. For the implementation of maintenance works, the installation of a bypass system is recommended.

The dryer was designed in such a manner that vibrations that may occur during operation are limited. Therefore, it is advisable to employ connecting lines (flexible hoses, vibration-inhibiting fittings etc.) which protect the dryer against possible vibrations in the pipework.



Note! **Contaminated intake air!**

In the event that the intake air is strongly contaminated (ISO 8573.1 class 3.-3) or poorer quality, we recommend the additional installation of a prefilter (e.g. ProPure), to avoid clogging of the heat exchanger.



CAUTION!

During the piping of the dryer, the inlet and outlet connections need to be supported as is shown in the illustration.
Non-observance will cause damage.

8.5 Electrical connections



Danger! **Supply voltage!**

The connection to the electric mains should only be carried out by qualified skilled personnel and must correspond to the legal provisions in force in your region.

Prior to connecting the device, please check the name plate to avoid exceeding the indicated values. The voltage tolerance is +/- 10%.

SPRPRC 200Z - 500Z 3PH dryers are supplied with a junction box on the back plate.

Make sure that suitable fuses or circuit breakers in accordance with the indications on the name plate are available.

A residual-current device (RCD) with $I_{\Delta n} = 0.03A$ is suggested. The cross-section of the power supply cable must correspond to the power consumption of the dryer. In this respect, the ambient temperature, the cable laying conditions, the length of the cables and the requirements of the local electricity supplier need to be considered.



Danger! **Supply voltage and missing earth connection!**

Important: ensure that the plant is connected to earth.

Do not use plug adapters at the power plug.

Possible replacement of the power plug must only be carried out by a qualified electrician.

8.6 Condensate drain



Danger!

Compressed air and condensate under pressure!

The condensate is discharged at system pressure.
The drain pipe needs to be secured.
Never direct the condensate drain pipe at persons.

The dryer is delivered with an already integrated electronically level-controlled ZL Drain. Connect the condensate drain with a collection system or container by properly screwing it on.
Do not connect the drain with pressurised plants.



Do not discharge the condensate into the environment.

The condensate accumulating in the dryer contains oil particles which were released into the air by the compressor.

Dispose of the condensate in accordance with the local provisions.

It is advisable to install a water-oil separator, to which the total amount of condensate from the compressors, dryers, tanks, filters etc. is supplied.

We recommend SPremier Pure Oil-Water Separator for dispersed compressor condensate.

9 Start-up

9.1 Preliminary stages



Note!

Exceeding of the operating parameters!

Ensure that the operating parameters comply with the nominal values indicated on the name plate of the dryer (voltage, frequency, air pressure, air temperature, ambient temperature etc.).

Prior to delivery, this dryer was thoroughly tested, packed and checked. Please verify the soundness of the dryer during the initial start-up and check the perfect functioning during the first operating hours.



The initial start-up must be carried out by qualified personnel.

During the installation and operation of this device, all national regulations regarding electronics and any other federal and state ordinances, as well as local provisions, need to be adhered to.



The operator and the user must ensure that the dryer is not operated without panels.

9.2 Initial start-up



Note!

The number of starts/stops by pressing the ON-OFF switch - pos. 1 control panel must be limited to six per hour.

Irreparable damage can be caused by starting up the device too often.



The method below should be applied during the first start-up, after longer downtimes or subsequent to maintenance works.

The start-up must be carried out by certified skilled personnel.

Processing sequence (see Section 11.1 "Control panel")

- Ensure that all steps of the "Installation" chapter have been carried out.
- Ensure that the connection to the compressed-air system is in accordance with the provisions and that the lines are fixed and supported properly.
- Ensure that the condensate drain pipe is fixed in accordance with the provisions and that it is connected with a collection system or a container.
- Ensure that the bypass system (if installed) is open and that the dryer is disconnected from the compressed-air system.
- Ensure that the manual valve of the condensate drainage cycle is open.
- Remove any packaging material and other items which may block the space around the dryer.
- Establish the mains connection (plug into socket).
- Switch on the main switch - pos. A control panel.
- Wait at least two hours before starting the dryer (the crankcase heater of the compressor needs to heat up the compressor oil).
- Start the dryer by switching on the main switch on the control panel (pos. 1).
- Make sure that the electronic control unit is switched on.
- If the temperature displayed on the electronic control unit is sufficiently high, verify that the refrigerating compressor starts within a few minutes. **NOTE!** – With low temperatures, the refrigerating compressor will remain OFF.
- **Ensure that the fan runs properly – wait for the first interventions.**
- Wait until the dew point remains stable.
- Slowly open the air inlet valve.
- Slowly open the air outlet valve.
- Slowly close the central bypass valve of the system (if installed).
- Check the pipes for air leakage.
- Ensure the proper functioning of the condensate drain cycle (wait for the first condensate discharges).



Note!

A dew point between 32°F (0°C) and +50°F (+10°C) displayed on the electronic control unit is considered to be correct according to the possible operating conditions (flow rate, air inlet temperature, ambient temperature etc.).

In the cycling operating mode (Energy Saving, ESS=YES – see section 11.12.7), the refrigerating compressor is switched ON and OFF by the electronic control unit, according to thermal load applied to the dryer.

The dryer needs to be switched on during the entire compressed-air usage time, even if the compressed-air compressor works periodically.

9.3 Shut down and restart



During short-term inactivity (max. two to three days), it is advisable to leave the dryer and the control panel connected to the supply current circuit. Otherwise, it would be necessary at a restart of the dryer to wait two hours, until the crankcase heater of the compressor has heated up the oil in the compressor.



Shut down (see Section 11.1 "Control panel")

- Ensure that the dew point temperature indicated on the electronic control unit is stable.
- Interrupt the compressed-air supply.
- After a few minutes, stop the dryer by switching off the main switch on the control panel (pos. 1).



Restart (see Section 11.1 "Control panel")

- Make sure that the condenser is clean.
- Start the dryer by switching on the main switch on the control panel (pos. 1).
- Ensure that the electronic control unit is switched on.
- If the temperature displayed on the electronic control unit is sufficiently high, verify that the refrigerating compressor starts within a few minutes. **NOTE!** – With low temperatures, the refrigerating compressor will remain OFF.
- Wait a few minutes; verify that the DewPoint temperature displayed on electronic control unit is correct and that the condensate is regularly drained.
- Establish the compressed-air supply.



Dryer remote control ON/OFF

- Remove the jumper between terminals 1 and 2 of the terminal strip and wire a potential-free contact (see electric diagram).
- Switch ON the main switch - pos. 1 on the control panel.
- Close the contact at terminals 1 and 2 to switch on the dryer.
- Open the contact at terminals 1 and 2 to switch off the dryer.



Only use potential-free contacts that are suitable for 230Vac. Ensure the sufficient insulation of potentially dangerous voltage-carrying components.



Note!

A dew point 32°F (0°C) and +50°F (+10°C) displayed on the electronic control unit is considered to be correct according to the possible operating conditions (flow rate, air inlet temperature, ambient temperature etc.).

In the cycling operating mode (Energy Saving, ESS=YES – see section 11.12.7), the refrigerating compressor is switched ON and OFF by the electronic control unit, according to thermal load applied to the dryer.

The dryer needs to be switched on during the entire compressed-air usage time, even if the compressed-air compressor works periodically.



Note!

The number of starts/stops by pressing the ON-OFF switch - pos. 1 control panel must be limited to six per hour. Irreparable damage can be caused by starting up the device too often.

10 Technical data

10.1 Technical data SPRPRC 200Z - 500Z 3phase 3/460/60

MODEL	SPRPRC	200Z	250Z	300Z	350Z	400Z	500Z
Air flow rate at nominal condition (1)	[scfm] [m ³ /h] [l/min]	200 340 5660	250 425 7075	300 509 8490	350 594 9905	400 679 11320	500 849 14150
Pressure DewPoint at nominal condition (1)	[°F (°C)]	38 (3)					
Nominal ambient temperature	[°F (°C)]	100 (38)					
Min...Max ambient temperature	[°F (°C)]	34...122 (1...50)					
Nominal inlet air temperature	[°F (°C)]	100 (38) max.158 (70)					
Nominal inlet air pressure	[psig (barg)]	100 (7)					
Max. inlet air pressure	[psig (barg)]	203 (14)					
Air pressure drop - Δp	[psi (bar)]	3.6 (0.25)		1.5 (0.10)		1.9 (0.13)	
Inlet - Outlet connections	[NPT-F]	1.1/2"		2"		2 1/2"	
Refrigerant type		R134a R407C					
Refrigerant quantity (2)	[oz (kg)]	37 (1.05)	41 (1.15)	60 (1.70)	63 (1.80)	74 (2.10)	81 (2.30)
Cooling air fan flow	[cfm (m ³ /h)]	1500 (2500)	1650 (2800)	1700 (2900)	1700 (2900)	2100 (3600)	2200 (3700)
Heat Rejection	[btu/hr (kW)]	13700 (4.02)	14200 (4.16)	14900 (4.37)	18200 (5.33)	24900 (7.30)	32300 (9.47)
Standard Power Supply (2)	[PhV/Hz]	3/460/60					
Nominal electric consumption	[kW] [A]	1.22 1.9	1.38 2.1	1.41 2.2	1.80 2.8	2.70 4.2	2.97 4.5
Full load amperage (FLA)	[A]	4.5					
Max. noise level at 1 m	[dba]	< 70					
Weight	[lb (kg)]	159 (72)	176 (80)	238 (108)	243 (110)	353 (160)	375 (170)

(1) The nominal condition refers to an ambient temperature of 100°F (38°C) with inlet air at 100 psig (7 barg) and 100°F (38°C).

(2) Check the data shown on the identification plate.

11 Technical description

11.1 Control panel

The control panel explained below is the only dryer user interface.

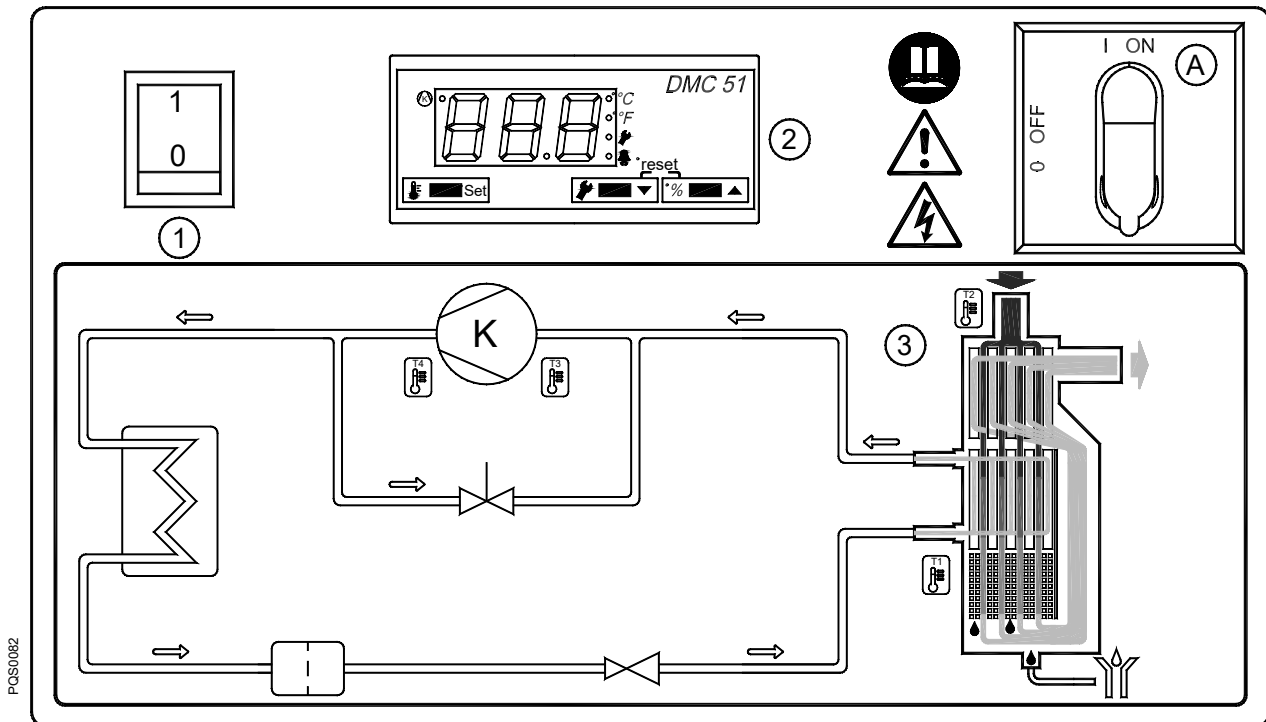

- | | | | |
|---|---------------|---|------------------------------------|
| A | Main switch | 2 | Electronic control unit DMC51 |
| 1 | ON-OFF switch | 3 | Air and refrigerant-gas flow chart |

11.2 Functional description

Operating principle – All dryer models described in this manual function according to the same principle. The hot and moisture-loaded air is led into an air/air heat exchanger. Afterwards, the air flows through an evaporator, which is also known as an air/refrigerant heat exchanger. The air temperature is reduced to approximately 36°F (2°C), so that water vapour condenses to liquid. The continuously accumulating condensate is collected in the separator to be discharged via the condensate drain. Subsequently, the cold and dry air is led through the air/air heat exchanger, so that it is reheated to up to 46°F (8°C) below the inlet temperature when leaving the dryer.

Refrigeration cycle – The refrigerant is conducted through the compressor and reaches a condenser under high pressure. There, cooling-down takes place, making the refrigerant condense to a liquid state which is under high pressure. The liquid is pressed through a capillary tube where the resulting pressure drop ensures that the refrigerant evaporates at a defined temperature. The liquid refrigerant which is under low pressure is led into the heat exchanger, where it expands. The cold resulting from the expansion serves to cool down the compressed air in the heat exchanger. During this process, the refrigerant evaporates. The low-pressure gas is resupplied to the compressor, where it is compressed again.

Operation in cycling mode (Energy Saving, ESS=YES – see section 11.12.7) – The DMC51 electronic controller constantly monitors the temperature of the DewPoint. In low load conditions, the temperature of the DewPoint tends to fall close to the freezing point, at this point the DMC51 controls the switching off of the compressor.

The compressor will be started again when the DewPoint temperature rises above a target value. To avoid an excessive number of cycles, DMC51 keeps the compressor on for a minimum time (about 6 minutes) within which, if necessary, will activate a solenoid valve EVH that enables the operation of the hot gas by-pass valve. In this way the compressor cannot make more than 10 cycles per hour. The solenoid valve EVL and the check valve CHV (where installed) help to extend the off time of the compressor and avoid the immediate balancing of high and low pressures of the refrigerant circuit. The solenoid valve EVL is activated before the compressor to balance the pressures and is kept active for the entire time during which the compressor is on.

With these dryers, the energy consumption will be adjusted closely proportional to the thermal load applied to the dryer itself, allowing considerable energy savings in the majority of applications.

Operation in hot gas by-pass mode (NO Energy Saving, ESS=NO – see section 11.12.7) – The DMC51 electronic controller constantly keep activated the compressor, the solenoid valve EVH and the solenoid valve EVL. In cases of a reduced compressed-air load, the excess refrigerant is bypassed automatically to the compressor via the hot gas bypass valve.

11.3 Flow chart

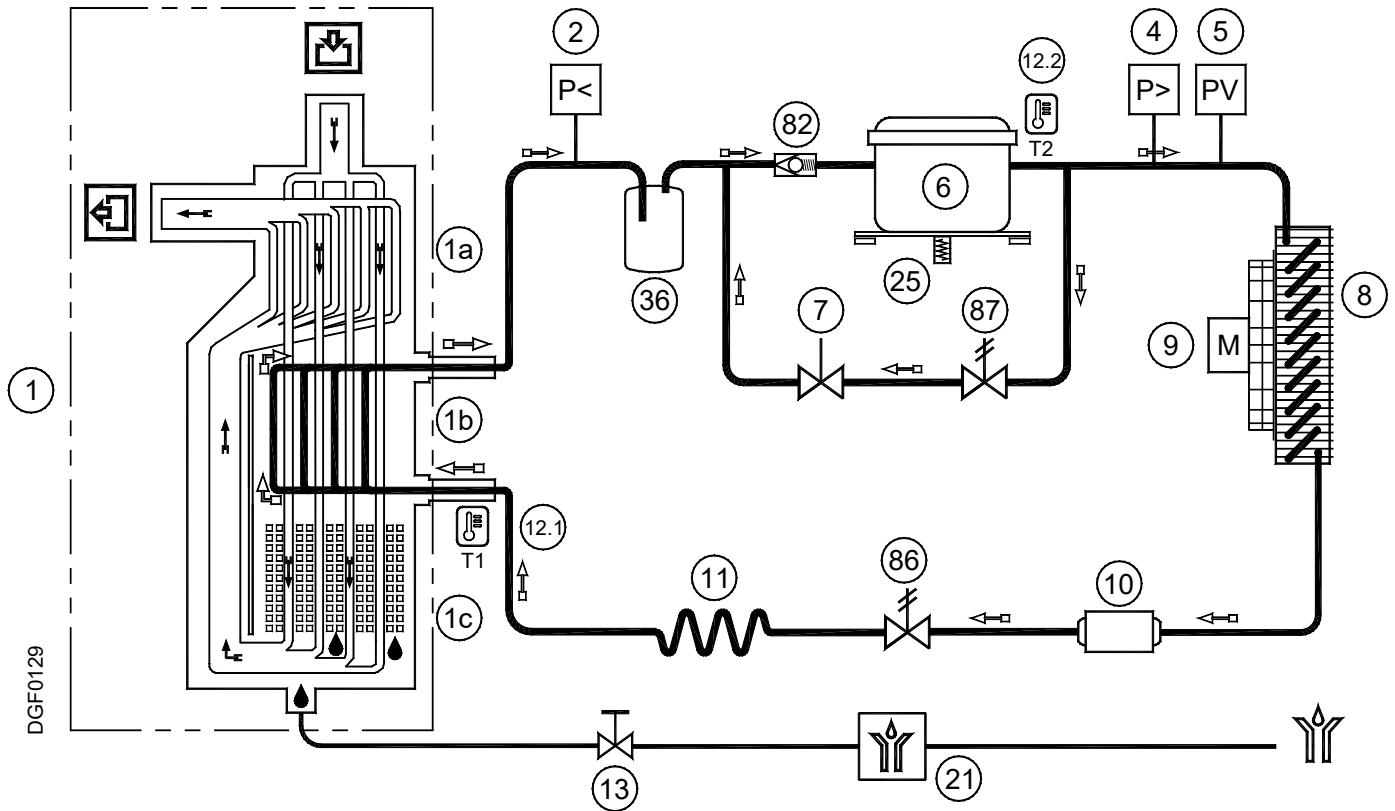

- | | | | |
|---|--------------------------------------|------|--|
| 1 | Aluminium heat exchanger module | 10 | Filter dryer |
| a | – Air/air heat exchanger | 11 | Capillary tube |
| b | – Air/refrigerant heat exchanger | 12.1 | T1 temperature sensor (dew point) |
| c | – Condensate separator | 12.2 | T2 temperature sensor (compressor discharge) |
| 2 | Refrigerant pressure switch LPS (P<) | 13 | Condensate drain service valve |
| 4 | Refrigerant pressure switch HPS (P>) | 21 | ZL Drain |
| 5 | Refrigerant fan pressure switch PV | 25 | Compressor crankcase heater |
| 6 | Refrigerating compressor | 36 | Suction refrigerant separator |
| 7 | Hot-gas bypass valve | 82 | Check valve CHV |
| 8 | Condenser | 86 | Liquid solenoid valve EVL |
| 9 | Condenser fan | 87 | Hot gas solenoid valve EVH |

⇒ Compressed-air flow direction

⇨ Refrigerant gas flow direction

11.4 Refrigerating compressor

The employed refrigerating compressors are constructed by leading manufacturers. The hermetically sealed construction is absolutely gastight. The integrated safeguard protects the compressor against overheating and excess current. The protection is automatically reset as soon as the nominal conditions are reached again.

11.5 Condenser

The condenser is the component in which the gas coming from the compressor is cooled down, condensed and liquefied. Under no circumstances must the temperature of the ambient air exceed the nominal values. It is also important that the condenser unit is kept free from dust and other impurities.

11.6 Filter dryer

Despite controlled vacuuming, traces of moisture can accumulate in the refrigeration cycle. The filter dryer serves to absorb this moisture and to bond it.

11.7 Capillary tube

The capillary tube is a copper tube with a reduced diameter which is located between the condenser and the evaporator, serving as a restrictor to reduce the pressure of the refrigerant. The pressure reduction serves to reach an optimum temperature inside of the evaporator. The lower the outlet pressure at the capillary tube, the lower the evaporation temperature.

The length and the inner diameter of the capillary tube are exactly dimensioned to ensure the performance of the dryer. Settings or maintenance works are not required.

11.8 Aluminium heat exchanger

The heat exchanger module consists of an air/air heat exchanger, an air/refrigerant heat exchanger, and of a high-performance separator. The compressed air flows top-down through the heat exchanger. The large cross-sections of the flow passages cause low flow rates and low compressed-air losses. In the air/air heat exchanger, the heat exchange is effected in a reverse current. This guarantees maximum heat transfer. The heat transfer in the air/refrigerant heat exchanger also takes place in a reverse current. This allows full evaporation of the refrigerant. The high-performance separator ensures almost complete separation of the condensate. Maintenance of the high-performance separator is not required.

11.9 Hot-gas bypass valve

At partial load, the valve directly returns a part of the hot gas to the suction line of the refrigerating compressor. The evaporation temperature and the evaporation pressure remain constant.



ADJUSTMENT

The hot gas by-pass valve is adjusted during the manufacturing testing phase. As a rule no adjustment is required; anyway if it is necessary the operation must be carried out by an experienced refrigerating engineer.

WARNING

the use of 1/4" Schrader service valves must be justified by a real malfunction of the refrigerating system. Each time a pressure gauge is connected, a part of refrigerant is exhausted.

Without compressed air flow through the dryer, rotate the adjusting screw (position A on the drawing) until the following value is reached:

Hot gas setting :

R134.a pressure 31.9 psig (+ 1.45 / -0 psi) [2.2 barg (+0.1 / -0 bar)]

R407C pressure 68.2 psig (+1.45 / -0 psi) [4.7 barg (+0.1 / -0 bar)]

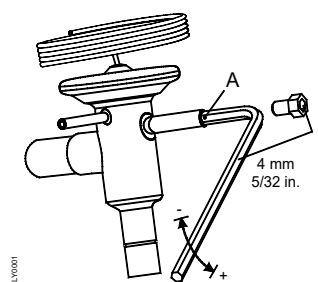

11.10 Refrigerant pressure switches LPS – HPS – PV

To ensure the operational reliability and the protection of the dryer, a series of pressure switches are installed in the gas cycle.

LPS : Low-pressure guard on the suction side of the compressor, which is triggered when the pressure drops below the predetermined value. The values are reset automatically as soon as the nominal conditions are re-established.

Calibrated pressure :	R 134.a	Stop 10.2 psig (0.7 barg) - Restart 24.7 psig (1.7 barg)
	R 407 C	Stop 24.7 psig (1.7 barg) - Restart 39.2 psig (2.7 barg)

HPS : The high-pressure control unit on the discharge side of the compressor is activated when the pressure exceeds the predetermined value. It has a manual reset button on the control itself.

Calibrated pressure :	R 134.a	Stop 290 psig (20 barg) - Manual reset P<203 psi (P<14 bar)
	R 407 C	Stop 435 psig (30 barg) - Manual reset P<334 psi (P<23 bar)

PV : Fan control pressure switch which is installed on the discharge side of the compressor. It keeps the condensation temperature and pressure constantly in the range of the preadjusted limit values

Calibrated pressure :	R 134.a	Start 160 psig (+7.25 / -0 psi) [11 barg (+0.5 / -0 bar)]
		Stop 116 psig (+0 / -7.25 psi) [8 barg (+0 / -0.5 bar)]
	R 407 C	Start 261 psig (+7.25 / -0 psi) [18 barg (+0.5 / -0 bar)]
		Stop 203 psig (+0 / -7.25 psi) [14 barg (+0 / -0.5 bar)]

11.11 Compressor crankcase heater

At low temperatures, the oil can more easily intermix with the refrigerant gas. When the compressor starts, oil can be drawn into the refrigeration cycle, leading to "hydraulic shocks".

To prevent this, a resistance heater is installed in the suction side of the compressor. When the system is connected with the electric mains and the compressor is idle, the heater will keep the oil at the correct temperature.

This heater is controlled via a temperature switch which prevents the overheating of the oil.

Note: The heater must be connected to the mains at least a few hours prior to the start-up of the refrigerating compressor.

11.12 DMC51 electronic control unit

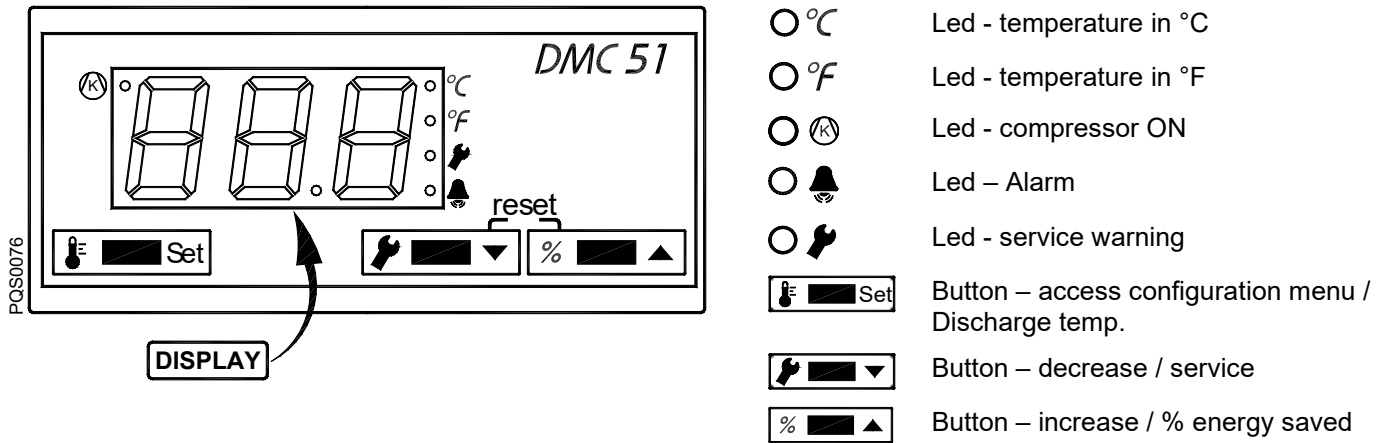

The DMC51 controls all the operations, alarms and dryer operation set-up.

11.12.1 Switching the dryer on

Connect the dryer to the electric mains and switch it on via the ON/OFF switch (pos. 1 Section 11.1). During normal operation, the display shows the dew point temperature.

11.12.2 Switching the dryer off

Switch the device off via the ON/OFF switch (pos. 1 Section 11.1).

11.12.3 Indication of the operating parameters

During normal operation, the display shows the dew point temperature (in °C or °F).

Led ○(K) shows that the compressor is ON.

Press the [thermometer] Set button and keep it pressed to display the compressor discharge temperature (probe T2 if installed).

Press the [wrench] ↓ button and keep it pressed to display the hours remaining until the next maintenance.

Press the [thermometer] Set + [wrench] ↓ buttons simultaneously and keep them pressed to display the total number of operating hours of the dryer (ie when dryer is powered)

Press the [wrench] ↑ button and keep it pressed to display the % of energy saved.

Note: The temperatures are indicated in °C or °F (LED ○ °C or ○ °F is on).
 The total operating hours and the hours until the next maintenance are indicated in the field 0...999 hours, and in thousand hours from 1.0 hours onwards (example: when the display shows 35, this means 35 hours and when the display shows 3.5, this means 3,500 hours).
 The % of energy saved is calculated considering the running hours of the compressor against the operating hours of the dryer (example: during 10 hours of powered dryer, compressor has ran for 4 hours, display shows 60% of energy saved).

11.12.4 Indication of a service warning





A service warning is an exceptional event and requires the attention of the operator/service technician. The dryer will not be stopped.

When a service warning is active, the  Led flashes.

When a service warning is no longer active but not reset yet (so it has been stored)  Led is continuously on.

In both cases the display shows the dew point temperature and the service warnings which are active or which are no longer active but not yet reset.

Service warnings are NOT automatically reset.

To **RESET** the service warning, the  Led must be continuously on (not flashing), keep pressed simultaneously  +  buttons for three seconds. Only the stored service warning will be reset. Service warnings which are still active continue to be indicated by the  Led flashing.

NOTE: the operator/service technician must check the dryer and eliminate the problem that caused the service warning.

Service warning	Description
HdP	HdP – High dew point: dew point too high, higher than the adjusted HdS value
LdP	LdP – Low dew point: dew point too low Setting T1 < -1°C (30°F) delay five minutes / reset T1 > -0.5°C (31°F)
SrV	SrV - Service: maintenance service time expired SrV

11.12.5 Indication of an alarm





An alarm is an exceptional event which, to avert damage from to the machine and the operator, always leads to the dryer stop.

When an alarm is active, the  LED flashes.

When an alarm is no longer active but not reset yet (so it has been stored)  Led is continuously on (in any case, the dryer remains OFF).

In both cases the display shows **OFF** and the alarms which are active or which are no longer active but not yet reset.

Alarms are NOT automatically reset.

To **RESET** the alarm, the  Led must be continuously on (not flashing), keep pressed simultaneously  +  buttons for three seconds. Only the stored alarm will be reset. Alarms which are still active continue to be indicated by the  Led flashing.



The dryer will start automatically subsequent to the reset of the alarms.

NOTE: the operator/service technician must check the dryer and eliminate the problem that caused the alarm.

Alarm	Description
LP	LP – Low pressure: the refrigerant low-pressure switch LPS has tripped.
Hdt	Hdt – High outlet temperature: compressor outlet temperature outside the safety limit Setting T2 > 110°C (230°F) delay one minute / reset T2 < 90°C (194°F)
ICE	ICE - ICE / Icing: Temperature in the exchanger (probe T1) is too low and leads to icing of the condensate. Setting T1 < -2°C (28°F) delay one minute / reset T1 > 0°C (32°F)
toC	toC – Too many Cycles : compressor has been cycled On/OFF unusually too often (stopped more than 5 times before reaching its minimum ON time)
PF1	PF1 – Probe 1 failure: failure probe T1
PF2	PF2 – Probe 2 failure: failure probe T2

11.12.6 Operation of the potential-free failure/alarm contact

The DMC51 is equipped with a 12Vdc signal (max 15 mA) to indicate service warning or alarm conditions.

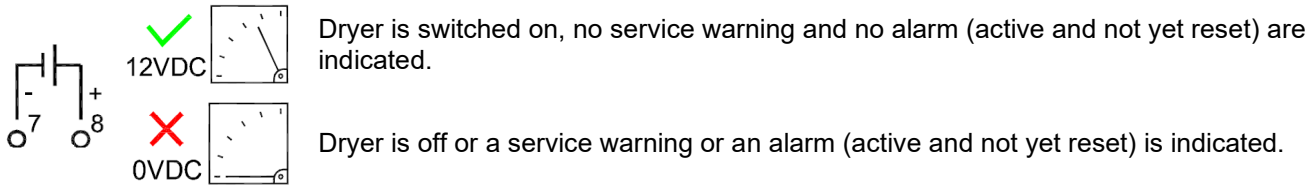

11.12.7 How to change operating parameters – SETUP menu

The setup menu can be used to change the dryer's operating parameters.



Only qualified personnel must be allowed to access to the setup menu. The manufacturer is not responsible for malfunctioning or failure due to modification to the operating parameters.

With dryer ON simultaneously press buttons + for at least 5 seconds to enter the setup menu.

Access to the menu is confirmed by message **HdS** on the display (first parameter of menu).

Keep pressed to display the value of the selected parameter and use arrows and to change the value. Release the button to confirm the value and skip to following parameter.

Press + to exit setup menu (if no button is pressed after 30 seconds the menu is exited automatically).

ID	Description	Limits	Resolution	Standard setup
HdS	HdS - High DewPoint Setting : service warning threshold for a high DewPoint (the service warning disappears when the temperature drop 0.5°C / 1°F below set point)	0.0...25.0 °C or 32 ... 77 °F	0.5 °C or 1 °F	20 or 68
Hdd	Hdd - High DewPoint Delay : high DewPoint service warning enable delay	00 ... 20 minutes	1 min	15
SrV	SrV - Service Setting : setting of service warning timer. 0.0 = service warning timer disabled.	0.0 ... 9.0 (x 1000) hours	0.1 (x1000) hours	8.0
SCL	SCL - Scale: display scale of temperatures.	°C ... °F	-	°C or °F
ESS	ESS – Energy Saving Set: selection if dryer run in energy saving cycle. YES = Energy saving mode is active (cycling mode). nO = Energy saving mode is not active (Hot Gas by-pass sytem)	YES...nO	-	YES

11.13 Electronically level-controlled ZL Drain

The electronically level-controlled ZL Drain boasts a special condensate management which ensures that condensate is discharged safely and without an unnecessary loss of compressed air. This drain has a condensate collection container in which a capacitive sensor continuously monitors the liquid level. As soon as the switching level is reached, the capacitive sensor transmits a signal to the electronic control and a membrane solenoid valve opens to discharge the condensate. The ZL Drain closes before compressed air emerges.



Note!

These ZL Drain were designed in particular for the operation in a **SPRPRC** refrigeration dryer. The installation in other compressed-air processing systems or the replacement with another drain brand can lead to malfunction. The maximum operating pressure (see name plate) must not be exceeded!

Ensure that the upstream valve is open when the dryer starts operation.

To obtain detailed information regarding drain functions, troubleshooting, maintenance and spare parts, please read the installation and operating instructions of the ZL Drain.

12 Maintenance, troubleshooting, spare parts and dismantling

12.1 Checks and maintenance



Certified skilled personnel

Installation works must exclusively be carried out by authorised and qualified skilled personnel. Prior to undertaking any measures on the SPRPRC 200Z - 500Z compressed-air refrigeration dryer, the certified skilled personnel⁴ shall read up on the device by carefully studying the operating instructions. The operator is responsible for the adherence to these provisions. The respective directives in force apply to the qualification and expertise of the certified skilled personnel.

For safe operation, the device must only be installed and operated in accordance with the indications in the operating instructions. In addition, the national and operational statutory provisions and safety regulations, as well as the accident prevention regulations required for the respective case of application, need to be observed during employment. This applies accordingly when accessories are used.



Danger!

Compressed air!

Risk of serious injury or death through contact with quickly or suddenly escaping compressed air or through bursting and/or unsecured plant components.

Compressed air is a highly dangerous energy source.

Never work on the dryer when the system is under pressure.

Never direct the compressed-air outlet or condensate drain hoses at persons.

The user is responsible for the proper maintenance of the dryer. Non-observance of the instructions in the "Installation" and "Maintenance, troubleshooting, spare parts and dismantling" chapters leads to the expiration of the guarantee. Improper maintenance may result in dangerous situations for the personnel and/or the device.



Danger!

Supply voltage!

Contact with non-insulated parts carrying supply voltage involves the risk of an electric shock resulting in injuries and death.

Only qualified and skilled personnel are authorised to run electrically-operated devices. Prior to undertaking maintenance measures at the device, the following requirements must be met:

Make sure that the power supply is switched off and that the device is off and marked for maintenance measures. Please also ensure that the power supply cannot be re-established during the works.



Prior to carrying out maintenance works at the dryer, switch it off and wait for at least 30 minutes.



Caution!

Hot surfaces!

During operation, several components can reach surface temperatures of more than 140°F (60°C). There is the risk of burns.

All components concerned are installed inside of the closed housing. The housing must only be opened by certified skilled personnel.

Some components can reach high temperatures during operation. Avoid any contact until the system or the component has cooled down.

⁴ Certified skilled personnel are persons who are authorised by the manufacturer, with experience and technical training, who are well-grounded in the respective provisions and laws and capable of carrying out the required works and of identifying and avoiding any risks during the machine transport, installation, operation and maintenance. Qualified and authorised operators are persons who are instructed by the manufacturer regarding the handling of the refrigeration system, with experience and technical training, and who are well-grounded in the respective provisions and laws.



DAILY:

- Check whether the dew point indicated on the electronics is correct.
- Ensure that the condensate drain system functions properly.
- Make sure that the condenser is clean.

EVERY 200 HOURS OR MONTHLY



- Clean the condenser using an air jet (max. 2 bar / 30 psig) inside out. Make sure not to damage the aluminium lamellae of the cooling package.
- Finally, verify the operation of the device.



EVERY 1,000 HOURS OR ANNUALLY

- Verify all screws, clamps and connections of the electric system to make sure that they are fastened securely. Check the device for broken and ruptured cables or cables without insulation.
- Check the refrigeration cycle for signs of oil and refrigerant leaks.
- Measure the current strength and note it down. Ensure that the read values are within the permissible limit values, as indicated in the specification table.
- Check the hose lines of the condensate drain and replace them, if required.
- Finally, verify the operation of the device.



EVERY 8,000 HOURS

- Replace ZL Drain Service Unit.

12.2 Troubleshooting



Certified skilled personnel

Installation works must exclusively be carried out by authorised and qualified skilled personnel. Prior to undertaking any measures on the SPRPRC 200Z - 500Z compressed-air refrigeration dryer, the certified skilled personnel shall read up on the device by carefully studying the operating instructions. The operator is responsible for the adherence to these provisions. The respective directives in force apply to the qualification and expertise of the certified skilled personnel.

For safe operation, the device must only be installed and operated in accordance with the indications in the operating instructions. In addition, the national and operational statutory provisions and safety regulations, as well as the accident prevention regulations required for the respective case of application, need to be observed during employment. This applies accordingly when accessories are used.



Danger!

Compressed air!

Risk of serious injury or death through contact with quickly or suddenly escaping compressed air or through bursting and/or unsecured plant components.

Compressed air is a highly dangerous energy source.

Never work on the dryer when the system is under pressure.

Never direct the compressed-air outlet or condensate drain hoses at persons.

The user is responsible for the proper maintenance of the dryer. Non-observance of the instructions in the "Installation" and "Maintenance, troubleshooting, spare parts and dismantling" chapters leads to the expiration of the guarantee. Improper maintenance may result in dangerous situations for the personnel and/or the device.



Danger!

Supply voltage!

Contact with non-insulated parts carrying supply voltage involves the risk of an electric shock resulting in injuries and death.

Only qualified and skilled personnel are authorised to run electrically-operated devices. Prior to undertaking maintenance measures at the device, the following requirements must be met:

Make sure that the power supply is switched off and that the device is off and marked for maintenance measures. Please also ensure that the power supply cannot be re-established during the works.



Prior to carrying out maintenance works at the dryer, switch it off and wait for at least 30 minutes.





Caution!
Hot surfaces!

During operation, several components can reach surface temperatures of more than 140°F (60°C). There is the risk of burns.

All components concerned are installed inside of the closed housing. The housing must only be opened by certified skilled personnel.

Some components can reach high temperatures during operation. Avoid any contact until the system or the component has cooled down.

FAULT	POSSIBLE REASON – SUGGESTED MEASURE
◆ The display of DMC51 is not lit	<ul style="list-style-type: none"> ⇒ Verify that the system is powered. ⇒ Verify the electric wiring. ⇒ HPS pressure switch has been activated – see specific point
◆ The compressor does not work.	<ul style="list-style-type: none"> ⇒ If ESS=YES (see section 11.12.7) – the Dew Point displayed on DMC51 is sufficiently low, the led  is OFF, so the compressor is not active – wait that the temperature becomes higher. ⇒ Activation of the compressor internal thermal protection – wait 30 minutes and then retry. ⇒ Verify the electric wiring. ⇒ If installed – the KC1 power contactor does not work – replace it ⇒ If installed – replace the internal thermal protection and/or the start-up relay and/or the start-up capacitor and/or the working capacitor. ⇒ DMC51 – The led  is ON – see specific point. ⇒ If the compressor still does not work, replace it.
◆ If ESS=YES (see section 11.12.7) - The compressor remains OFF unexpected short time.	<ul style="list-style-type: none"> ⇒ The OFF time of the compressor is related to the actual dryer thermal load. If dryer is running in low or no-load conditions and at mild/low ambient temperatures, and the compressor remains OFF for too short time (less than 3-5 minutes), check which of the following reasons is creating the malfunction: <ol style="list-style-type: none"> 1. The DewPoint probe T1 doesn't correctly detect the temperature - ensure the sensor is pushed into the bottom of probe well. 2. The thermal insulation of DewPoint probe T1 is damaged – restore the thermal insulation 3. The ambient temperature is too high or the room aeration is insufficient - provide proper ventilation. 4. The solenoid valve EVL is not operating correctly - see specific point. 5. If installed - The check valve CHV is jammed (open) - replace it.
◆ The fan of the condenser does not work	<ul style="list-style-type: none"> ⇒ Verify the electric wiring. ⇒ PV pressure switch is faulty - replace it. ⇒ There is a leak in the refrigerant circuit – contact a refrigeration engineer. ⇒ If the fan still does not work, replace it.

Maintenance, troubleshooting, spare parts and dismantling



- ◆ Dew point too high.
 - ⇒ The compressor does not work – see specific point.
 - ⇒ The DewPoint probe T1 doesn't correctly detect the temperature - ensure the sensor is pushed into the bottom of probe well.
 - ⇒ The ambient temperature is too high or the room aeration is insufficient - provide proper ventilation.
 - ⇒ The inlet air is too hot – restore nominal conditions.
 - ⇒ The inlet air pressure is too low – restore nominal conditions.
 - ⇒ The inlet air flow rate is higher than the rate of the dryer - reduce the flow rate - restore nominal conditions.
 - ⇒ The condenser is dirty – clean it.
 - ⇒ The condenser fan does not work – see specific point.
 - ⇒ The dryer does not drain the condensate – see specific point.
 - ⇒ If ESS=NO (see section 11.12.7) – The hot gas bypass valve is out of setting – contact a refrigeration engineer to restore nominal setting.
 - ⇒ If ESS=YES (see section 11.12.7) – DewPoint on this type of dryer is fluctuating (the compressor turns ON and OFF) and for some periods can reach values higher than normal - wait for the compressor start and the DewPoint will drop to lower temperature.
 - ⇒ The solenoid valve EVL is not operating correctly - see specific point.
 - ⇒ There is a leak in the refrigerant circuit – contact a refrigeration engineer.
 - ◆ Dew point too low with parameter ESS=NO (see sect. 11.12.7)
 - ⇒ The fan is always ON – verify the electric wiring, check the setting of PV pressure switch or PV pressure switch is faulty – replace it.
 - ⇒ The ambient temperature is too low – restore nominal conditions.
 - ⇒ The hot gas bypass valve is out of setting – contact a refrigeration engineer to restore nominal setting.
 - ◆ Dew point too low with parameter ESS=YES (see sect. 11.12.7)
 - ⇒ DewPoint on this type of dryer is fluctuating (the compressor turns ON and OFF) and for some periods can reach values lower than normal - wait until the DewPoint rise to normal temperature.
 - ⇒ The refrigerating compressor is always ON, even though the led  is OFF – verify the electric wiring or KC1 power contactor (if installed) is faulty – replace it.
 - ◆ Excessive pressure drop within the dryer.
 - ⇒ The dryer does not drain the condensate – see specific point.
 - ⇒ The dew point is too low – the condensate is frozen and blocks the air – see specific point.
 - ⇒ If ESS=YES (see section 11.12.7) – The DewPoint probe T1 doesn't correctly detect the temperature and the condensate freeze– ensure the sensor is pushed into the bottom of probe well.
 - ⇒ Check for throttling the flexible connection hoses.
 - ◆ The dryer does not drain the condensate.
 - ⇒ The condensate drain service valve is closed – open it.
 - ⇒ Verify the electric wiring.
 - ⇒ The dew point is too low – the condensate is frozen and blocks the air – see specific point.
 - ⇒ Inlet compressed air pressure is too low and the condensate is not drained – restore nominal conditions
 - ⇒ Electronic drainer is not operating correctly
 - ◆ The dryer continuously drains the condensate.
 - ⇒ Electronic drainer is dirty
 - ◆ Water within the line.
 - ⇒ **If installed - untreated air flows through the bypass unit** – close the bypass.
 - ⇒ The dryer does not drain condensate – see specific point.
 - ⇒ Dew point too high – see specific point.
 - ⇒ The compressed air pipeline downstream of the dryer are located at a very low ambient temperature and the remaining humidity in the compressed air is condensing: is required to review the plant compressed air distribution system.
 - ⇒ If ESS=YES (see section 11.12.7) – DewPoint on this type of dryer is fluctuating (the compressor turns ON and OFF). In low ambient temperature condition (winter season) the remaining humidity in the compressed air is condensing. Set ESS=NO (see section 11.12.7)
-

-
- ◆ The internal heat protection of the compressor has been activated
 - ⇒ Check which of the following reasons has caused the activation:
 1. Excessive thermal load – restore the standard operating conditions.
 2. The inlet air is too hot – restore the nominal conditions.
 3. The ambient temperature is too high or the room aeration is insufficient – provide proper ventilation.
 4. The condenser unit is dirty – clean it.
 5. The fan does not work – see specific point.
 6. If ESS=NO (see section 11.12.7) – The hot gas bypass valve is out of setting – contact a refrigeration engineer to restore nominal setting.
 7. The solenoid valve EVL is not operating correctly - see specific point.
 8. There is a leak in the refrigerant circuit – contact a refrigeration engineer.
 - ⇒ wait 30 minutes and then retry.
-
- ◆ The solenoid valve EVL or EVH doesn't operate correctly
 - ⇒ The solenoid valve is not activated and there is no voltage to the coil – verify the electric wiring.
 - ⇒ The solenoid valve is not activated and there is no voltage to the coil – the internal relay of DMC51 is faulty – replace DMC51.
 - ⇒ The solenoid valve is not activated and there is voltage to the coil – the coil is faulty – replace it.
 - ⇒ The solenoid valve is not activated and there is voltage to the coil – the solenoid valve is jammed - contact a refrigeration engineer for the replacement.
 - ⇒ The solenoid valve is always activated and there is always voltage to the coil – verify the electric wiring
 - ⇒ The solenoid valve is always activated and there is always voltage to the coil – the internal relay of DMC51 is faulty – replace DMC51.
 - ⇒ The solenoid valve is always activated and there is no voltage to the coil – the solenoid valve is jammed - contact a refrigeration engineer for the replacement.
-
- ◆ The HPS high-pressure switch has been activated.
 - ⇒ Check which of the following reasons has caused the activation:
 1. The ambient temperature is too high or the room aeration is insufficient – provide proper ventilation.
 2. The condenser is dirty – clean it.
 3. The fan does not work – see specific point.
 4. The solenoid valve EVL is not operating correctly - see specific point
 - ⇒ Reset the pressure switch by pressing the button on the switch itself – check the proper operation of the dryer.
 - ⇒ The HPS pressure switch is faulty – contact a refrigeration engineer for the replacement.
-
- ◆ The LPS low-pressure switch has been activated.
 - ⇒ There is a leak in the refrigerant circuit – contact a refrigeration engineer.
 - ⇒ The solenoid valve EVL is not operating correctly - see specific point
 - ⇒ The solenoid valve EVH is not operating correctly - see specific point
 - ⇒ The hot-gas bypass valve is faulty – contact a refrigeration engineer for the replacement
 - ⇒ The pressure switch reset automatically when normal conditions are restored – check the proper operation of the dryer.
-
- ◆ If T2 installed:
the alarm **Hdt** (Hdt) compressor outlet temperature too high – has been triggered.
 - ⇒ Check which of the following reasons has caused the alarm:
 1. Excessive thermal load – restore the standard operating conditions.
 2. The inlet air is too hot – restore the nominal conditions.
 3. The ambient temperature is too high or the room aeration is insufficient – provide proper ventilation.
 4. The condenser unit is dirty – clean it.
 5. The fan does not work – see specific point.
 6. The fan is always ON – verify the electric wiring, verify the setting of PV pressure switch or the PV pressure switch is faulty – contact a refrigeration engineer to replace it
 7. The T2 sensor is faulty – replace it
 8. If ESS=NO (see section 11.12.7) – The hot gas bypass valve is out of setting – contact a refrigeration engineer to restore nominal setting.
 9. The solenoid valve EVL is not operating correctly - see specific point
 10. There is a leak in the refrigerant circuit – contact a refrigeration engineer.



Maintenance, troubleshooting, spare parts and dismantling



- ◆ The alarm **toC** (toC), - ON/OFF cycles of the compressor too frequent – has been triggered
- ⇒ If ESS=YES (see section 11.12.7) - The refrigerating compressor must remain ON for a minimum time (approx. 6 minutes) within which, if necessary, DMC51 will activate the solenoid EVH that enables the operation of the hot gas by-pass valve. To avoid freezing, if the DewPoint drops too low in despite the hot gas by-pass valve is in operation, the compressor is switched OFF before its minimum ON time (approx. 6 minutes). If this happens too many times the alarm **toC** (TOC) is activated to avoid damaging the compressor.
- ⇒ Check which of the following reasons has caused the alarm:
1. The inlet air is too cold – restore the nominal conditions.
 2. The ambient temperature is too low - restore the nominal conditions.
 3. The hot gas bypass valve is out of setting – contact a refrigeration engineer to restore nominal setting.
 4. The solenoid valve EVH is not operating correctly - see specific point.

- ◆ The alarm **ICE** (ICE) has been triggered
- ⇒ Check which of the following reasons has caused the alarm:
1. The inlet air is too cold – restore the nominal conditions.
 2. The ambient temperature is too low - restore the nominal conditions.
 3. The refrigerating compressor is always ON, even though the led  is OFF – verify the electric wiring or KC1 power contactor (if installed) is faulty – replace it.

- ◆ DMC51 - The LED  is ON or flashing
- ⇒ With  LED flashing: one or more alarms are active and the display shows **OFF** and the active alarms.
- ⇒ With  LED lit: one or more alarms are waiting to be reset and the display shows **OFF** and the alarms that are no longer active but not yet reset.
- ⇒ The alarms are displayed by the following messages:
1. **LP** : LP - LPS pressure switch activated (low pressure) – see specific paragraph.
 2. **Hdt** : Hdt - Compressor discharge temperature too high (probe T2) – see specific paragraph.
 3. **ICE** : ICE - Temperature inside the exchanger too low (probe T1) – the dew point is too low – see specific paragraph.
 4. **toC** : toC – ON/OFF cycles of the compressor too frequent – Compressor has been repeatedly switched OFF before its minimum ON time (approx. 6 minutes) - see specific paragraph.
 5. **PF1** : PF1 - Failure temperature probe T1 (DewPoint) – verify electric wiring and/or replace probe.
 6. **PF2** : PF2 – Failure temperature probe T2 (compressor outlet) – If probe T2 installed : verify electric wiring and/or replace probe; If probe T2 not installed : verify electric wiring and/or replace the resistor R.

NOTE: after solving the problem, the alarms must be reset (simultaneously press the  +  buttons for three seconds).

- ◆ DMC51 - The LED  is ON or flashing
- ⇒ With  LED flashing, one or more service warnings are active.
- ⇒ With  LED lit: one or more service warnings are waiting to be reset. The display shows the dew point temperature and the active or not reset service warning.
- ⇒ The service warnings are displayed by the following messages:
1. **HdP** : HdP - Dew point too high (higher than the set HdS value) – see specific paragraph.
 2. **LdP** : Ldp - Dew point too low – see specific paragraph.
 3. **SrV** : SrV - Service - maintenance notification time expired (parameter SrV) – carry out the scheduled maintenance and reset the hour meter.

⇒ **NOTE: after solving the problem, the service warnings must be reset (simultaneously press the  +  buttons for three seconds).**

12.3 Recommended spare parts

Spare parts list is printed on a dedicated sticker applied inside the dryer. On this sticker each spare part is identified with its ID Number and related Spare Part Number. Here below the cross-reference table between ID Numbers and exploded drawings Ref. with their description and quantity installed in the dryers.

ID N.		DESCRIPTION	SPRPRC					
			200Z	250Z	300Z	350Z	400Z	500Z
2	LPS	Pressure switch	1	1	1	1	1	1
4	HPS	Pressure switch	1	1	1	1	1	1
5	PV	Pressure switch	1	1	1	1	1	1
6	MC	Compressor	1	1	1	1	1	1
7		Hot gas by-pass valve	1	1	1	1	1	1
9	MV	Complete fan	1	1	1	1	1	1
10		Filter drier	1	1	1	1	1	1
12	BT	Temperature probe	2	2	2	2	2	2
17	DMC51	Display module	1	1	1	1	1	1
		Main module	1	1	1	1	1	1
		Cable main module to display	1	1	1	1	1	1
21	ELD	ZL Drain	1	1	1	1	1	1
		ZL Drain service unit	1	1	1	1	1	1
22	S1	Lighted switch	1	1	1	1	1	1
	QS	Main switch	1	1	1	1	1	1
86	EVL	Liquid solenoid valve	1	1	1	1	1	1
		Coil for liquid solenoid valve	1	1	1	1	1	1
87	EVH	Hot gas solenoid valve	1	1	1	1	1	1
		Coil for hot gas solenoid valve	1	1	1	1	1	1
60	FU	Fuse kit	1	1	1	1	1	1
	KC1	Contactor	1	1	1	1	1	1
	TF	Transformer	1	1	1	1	1	1

12.4 Maintenance works at the refrigeration cycle



Caution! Refrigerant!

Maintenance and repair works at refrigeration systems must only be carried out by service technicians in accordance with the local provisions.
The total amount of refrigerant in the system must be collected for recycling purposes, resource recovery or disposal.

The refrigerant must not be discharged into the environment.

When delivered, the dryer is ready to operate and filled with a refrigerant of the R134a or R407C type.



Should you detect a refrigerant leak, please contact a service technician. Prior to any intervention, the room needs to be ventilated.

When the refrigeration cycle needs to be refilled, please also contact a service technician.
You will find the refrigerant type and amount on the name plate of the dryer.

Properties of the refrigerants used:

Refrigerant	Chemical formula	MIK	GWP
R134a - HFC	CH ₂ FCF ₃	1000 ppm	1430
R407C - HFC	R32/125/134a (23/25/52) CHF ₂ CF ₃ /CH ₂ F ₂ /CH ₂ FCF ₃	1000 ppm	1773,85

12.5 Dismantling the dryer

When the dryer is dismantled, all parts and operating materials related to the plant need to be disposed of separately.



Component	Material
Refrigerant	R407C, R134a, oil
Roof and supports	Structural steel, epoxy paint coat
Refrigerating compressor	Steel, copper, aluminium, oil
Aluminium heat exchanger	Aluminium
Condenser unit	Aluminium, copper, structural steel
Pipe	Copper
Fan	Aluminium, copper, steel
Valve	Brass, steel
ZL Drain	PVC, aluminium, steel
Insulant	Synthetic rubber without CFCs, polystyrene, polyurethane
Electric cable	Copper, PVC
Electric parts	PVC, copper, brass



We recommend observing the safety provisions in force for the disposal of each material type.

The refrigerant contains lubricating-oil droplets which are released by the compressor.

The refrigerant must not be discharged into the environment. It must be sucked off from the dryer using a suitable device, and then needs to be supplied to a collection point.

13 Appendices

13.1 Dryer dimensions

13.1.1 Dryer dimensions SPRPRC 200Z-250Z 3phase

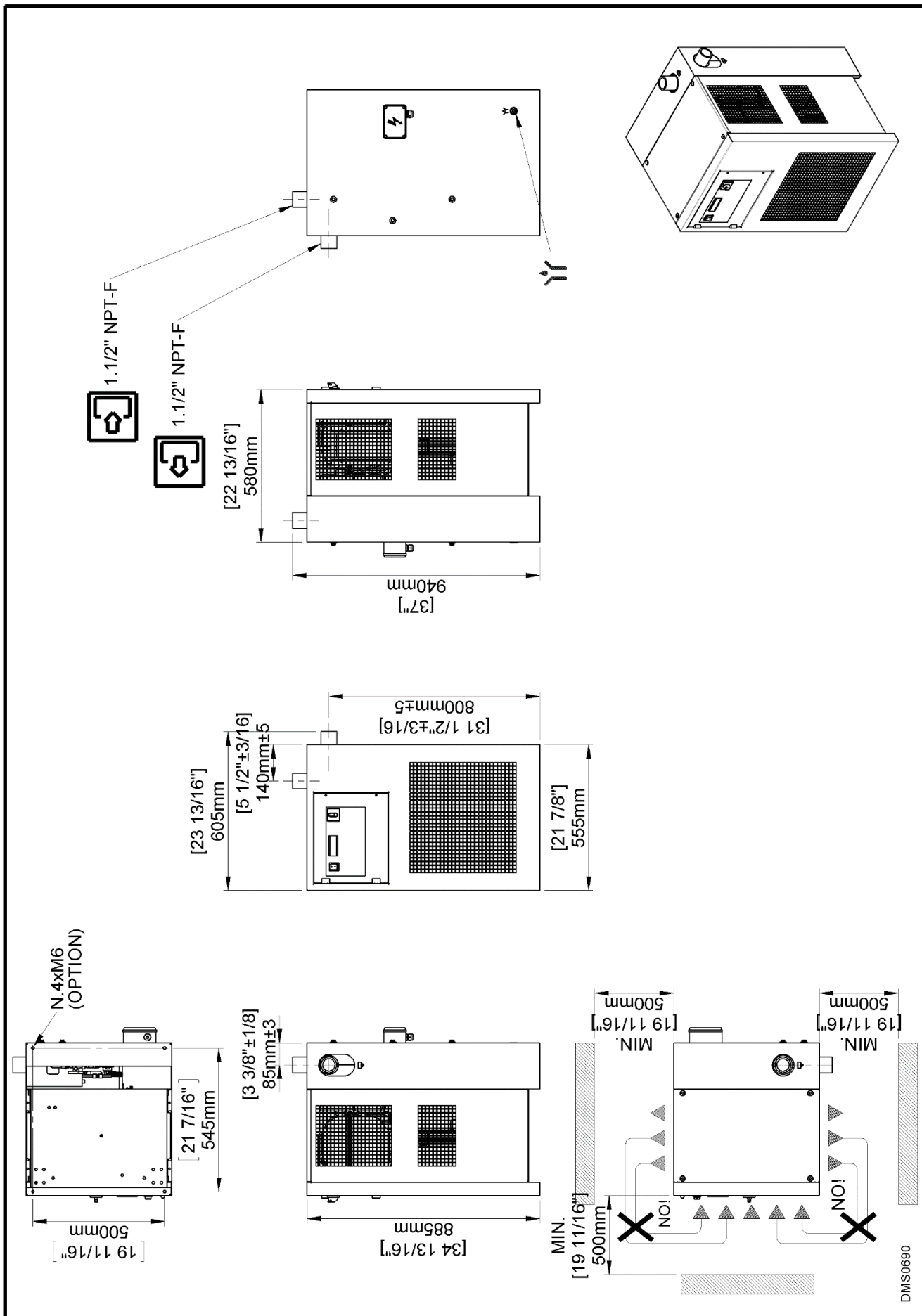

13.1.2 Dryer dimensions SPRPRC 300Z-350Z 3phase

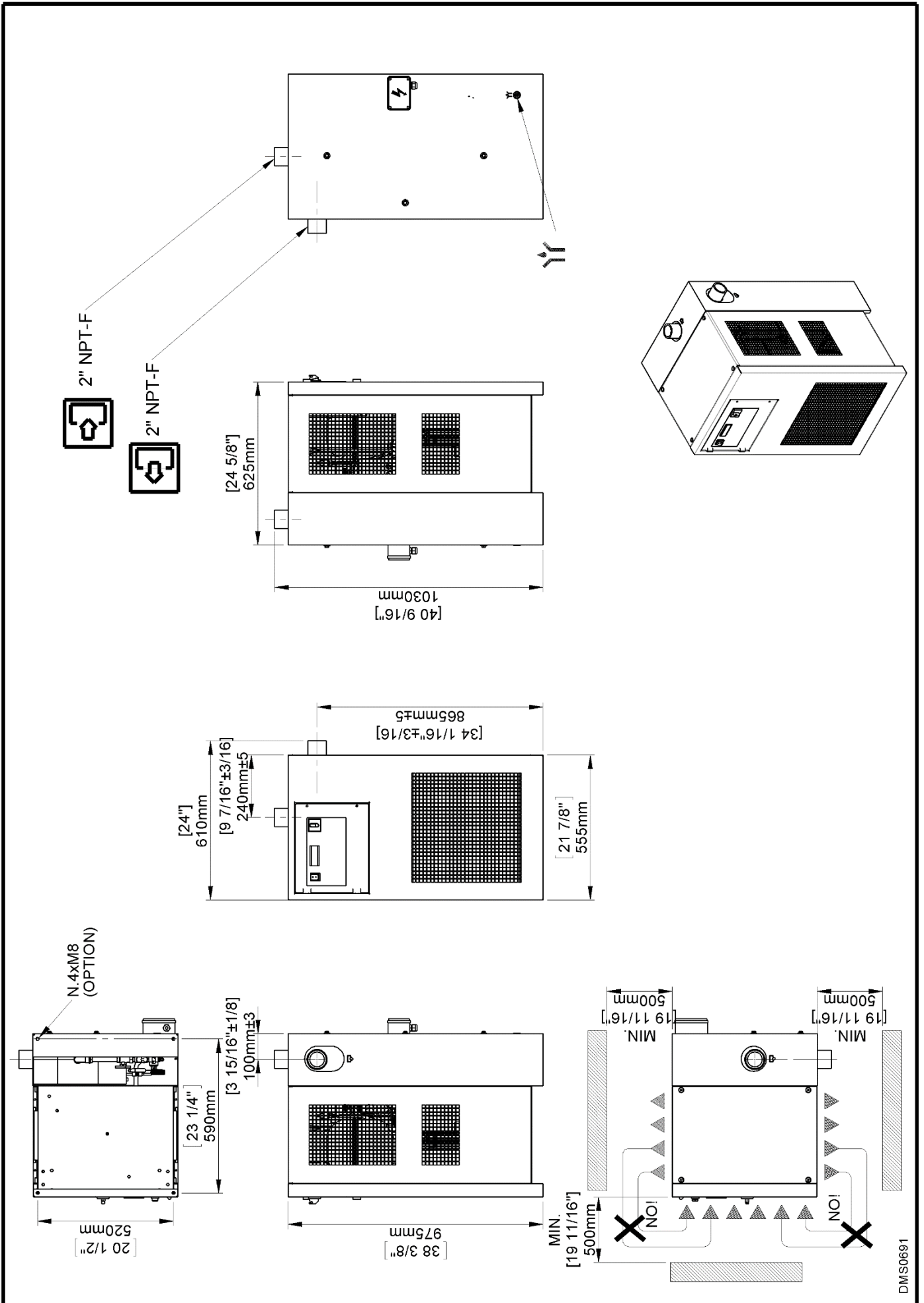

13.1.3 Dryer dimensions SPRPRC 400Z-500Z 3phase

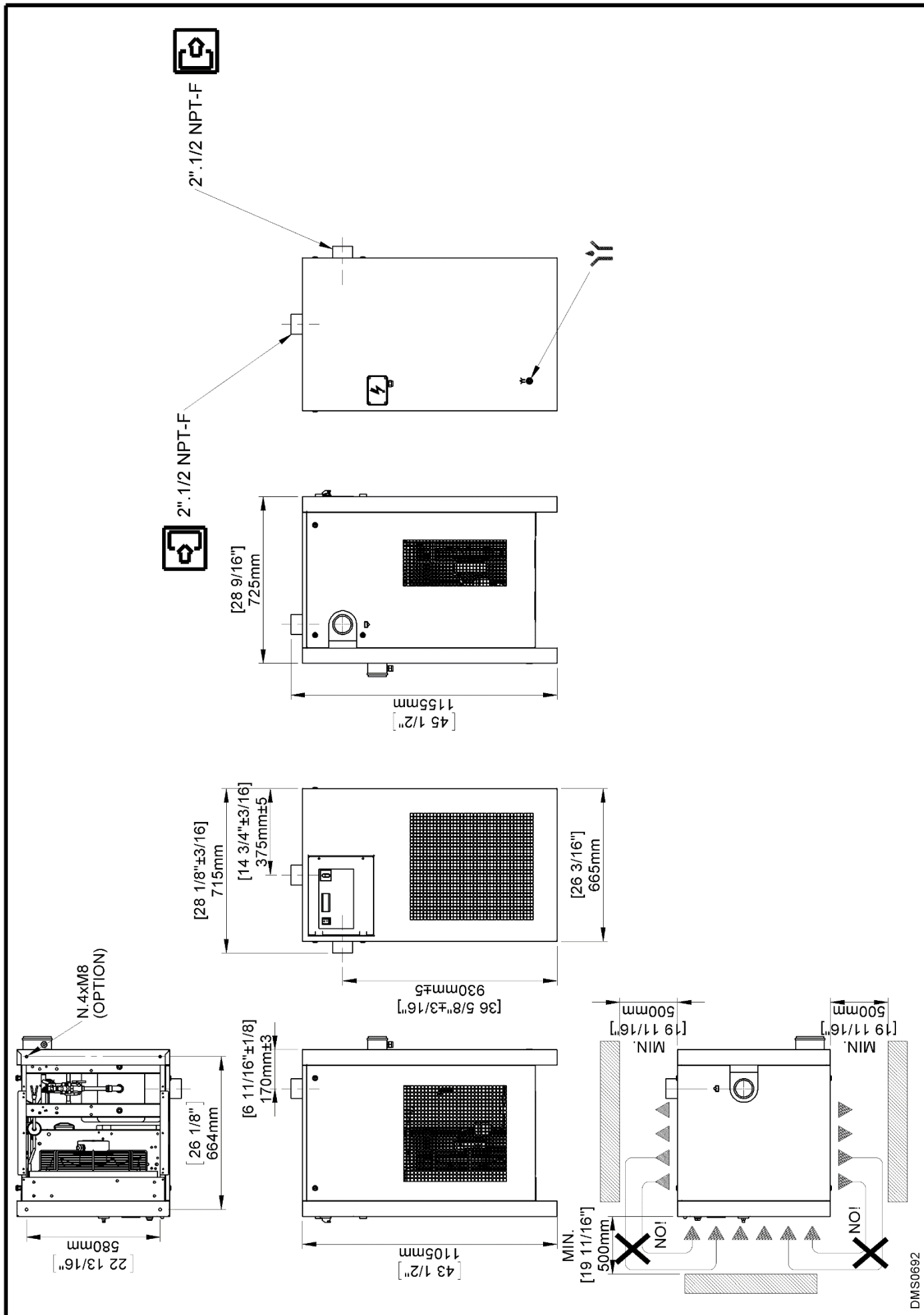

DMS0692

13.2 Exploded diagrams

13.2.1 Components of the exploded diagrams

1	AI drying module	51	Front panel
1.1	Insulation material	52	Back plate
2	Refrigerant pressure switch LPS	53	Right sidewall
4	Refrigerant pressure switch HPS	54	Left sidewall
5	Refrigerant fan pressure switch PV	55	Cover
6	Compressor	56	Base plate
7	Hot-gas bypass valve	57	Upper plate
8	Condenser	58	Carrier support
9	Condenser fan	59	Support bracket
9.1	Motor	60	Control panel
9.2	Blade	61	Electric connecting plug
9.3	Grid	62	Electric cabinet
10	Filter dryer	66	QE door
11	Capillary tube	81	Adhesive label flow chart
12	T1 temperature probe (dew point)	82	Check valve CHV
13	Condensate drain service valve	83	Service valve – High pressure side
17	Air dryer control	84	Service valve – Low pressure side
21	ZL Drain	86	Liquid solenoid valve EVL
22	Main switch	87	Hot gas solenoid valve EVH
36	Liquid separator	100	Autotransformer

13.2.2 Exploded diagram SPRPRC 200Z-250Z 3phase / AC

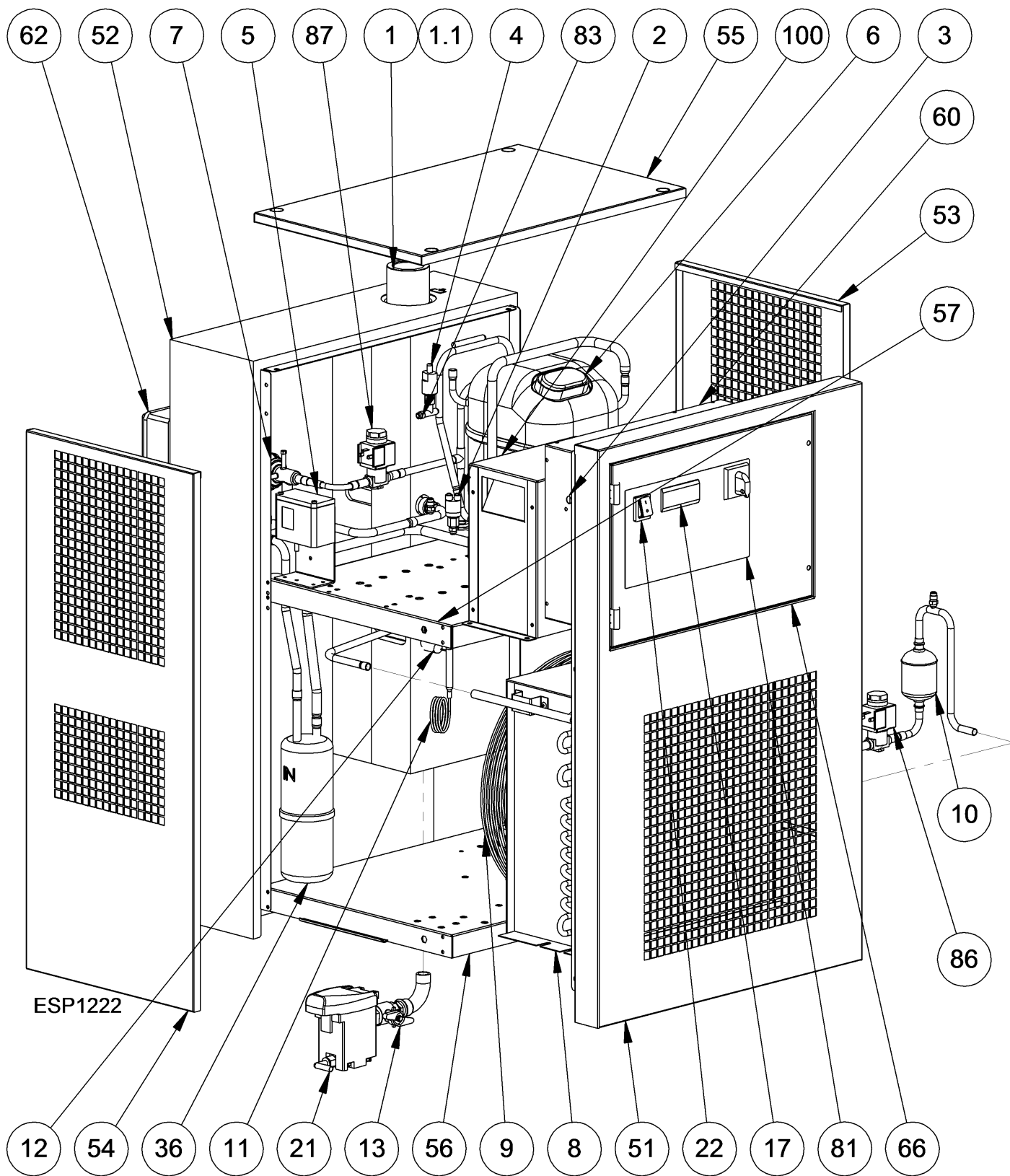

13.2.3 Exploded diagram SPRPRC 300Z-350Z 3phase / AC

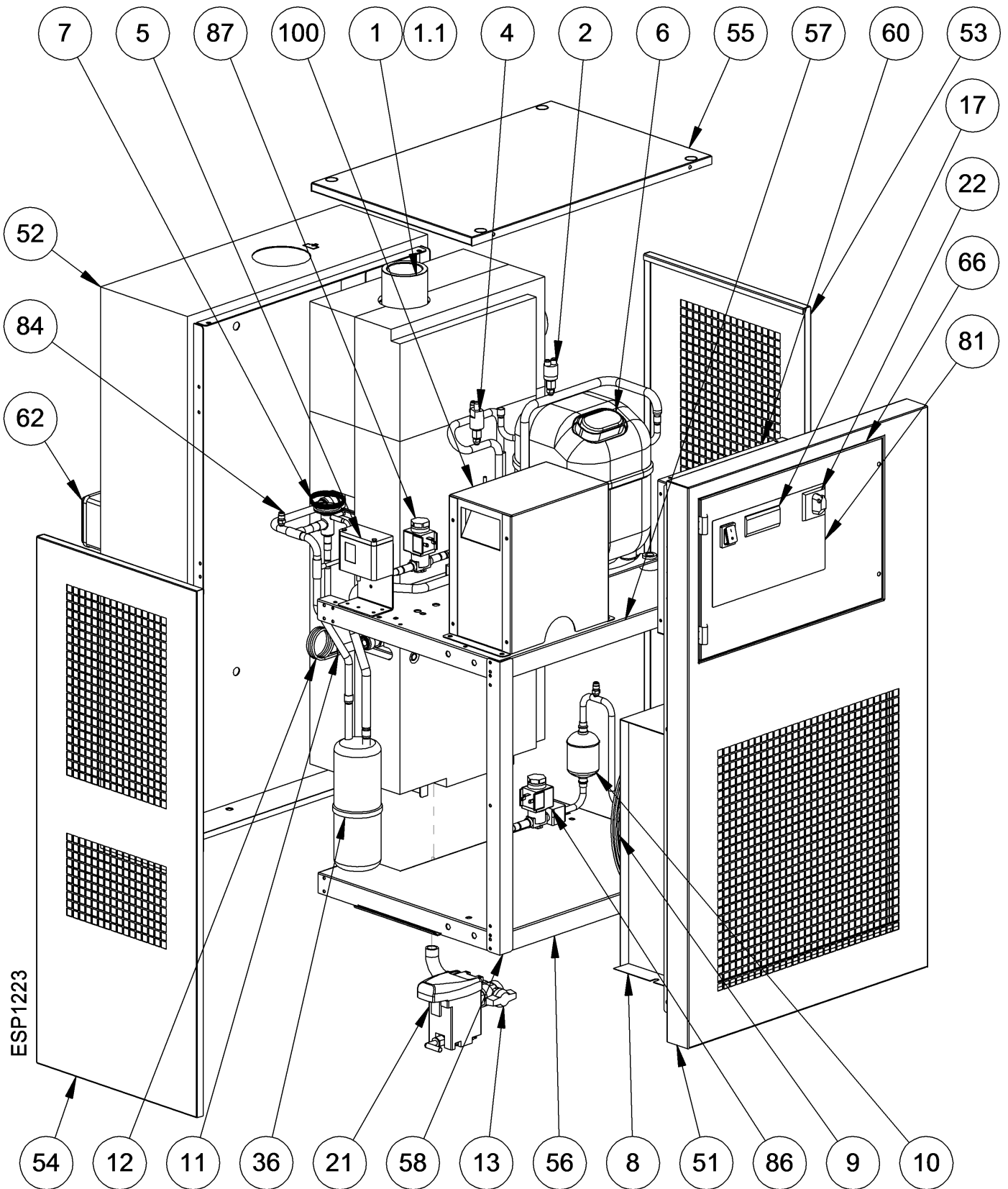

13.2.4 Exploded diagram SPRPRC 400Z-500Z 3phase / AC

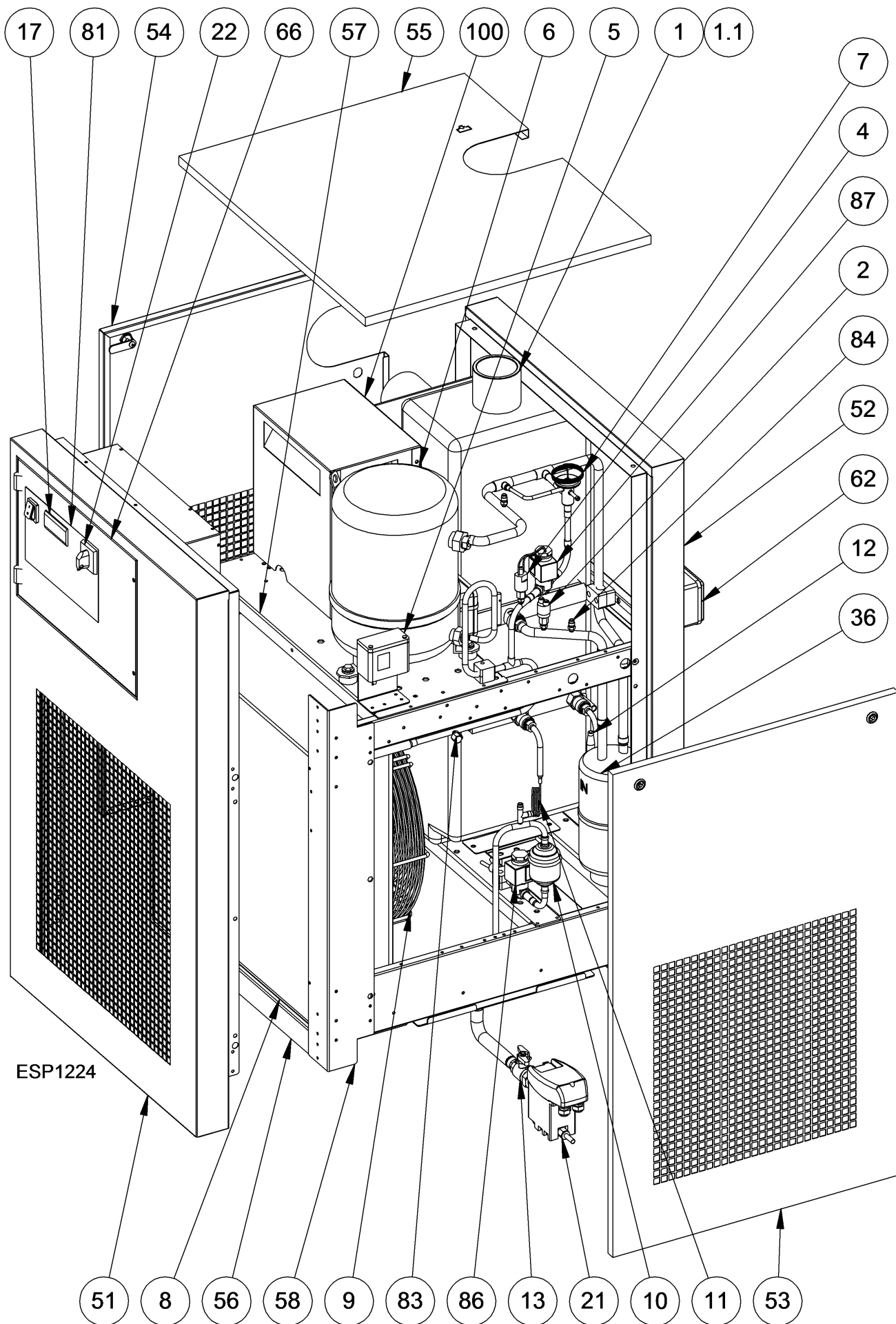

13.3 Electric diagrams

13.3.1 Electric diagrams – list of components

MC1	:	Compressor			
		KT	:	Compressor thermal protection	
		KR	:	Compressor starting relay	
		CS	:	Compressor starting capacitor	
		CR	:	Compressor operating capacitor	
MV1	:	Condenser fan			
		CV	:	Fan starting capacitor (if installed)	
DMC51	:	DMC51 electronic control unit – main module			
		DMC51 electronic control unit – display module			
BT1	:	T1 Temperature probe – dew point			
BT2	:	T2 Temperature probe – compressor discharge			
EVH	:	Hot gas solenoid valve			
EVL	:	Liquid solenoid valve			
KC	:	Compressor operating relay			
HPS	:	Pressure switch – compressor discharge side (HIGH PRESSURE)			
LPS	:	Pressure switch – compressor suction side (LOW PRESSURE)			
PV	:	Pressure switch – fan control			
ELD	:	ZL Drain			
S1	:	ON/OFF switch			
QS	:	Main switch with locking device			
RC	:	Compressor crankcase heater			
BOX	:	Electrical connection			
TR	:	Autotransformer			
NT4	:	Provided and cabled by the customer			
NT5	:	Limit of equipment			
BN	=	BROWN	OR	=	ORANGE
BU	=	BLUE	RD	=	RED
BK	=	BLACK	WH	=	WHITE
YG	=	YELLOW/GREEN	WH/BK	=	WHITE/BLACK

13.3.2 Electric diagram SPRPRC 200Z - 500Z 3phase Sheet 1/3

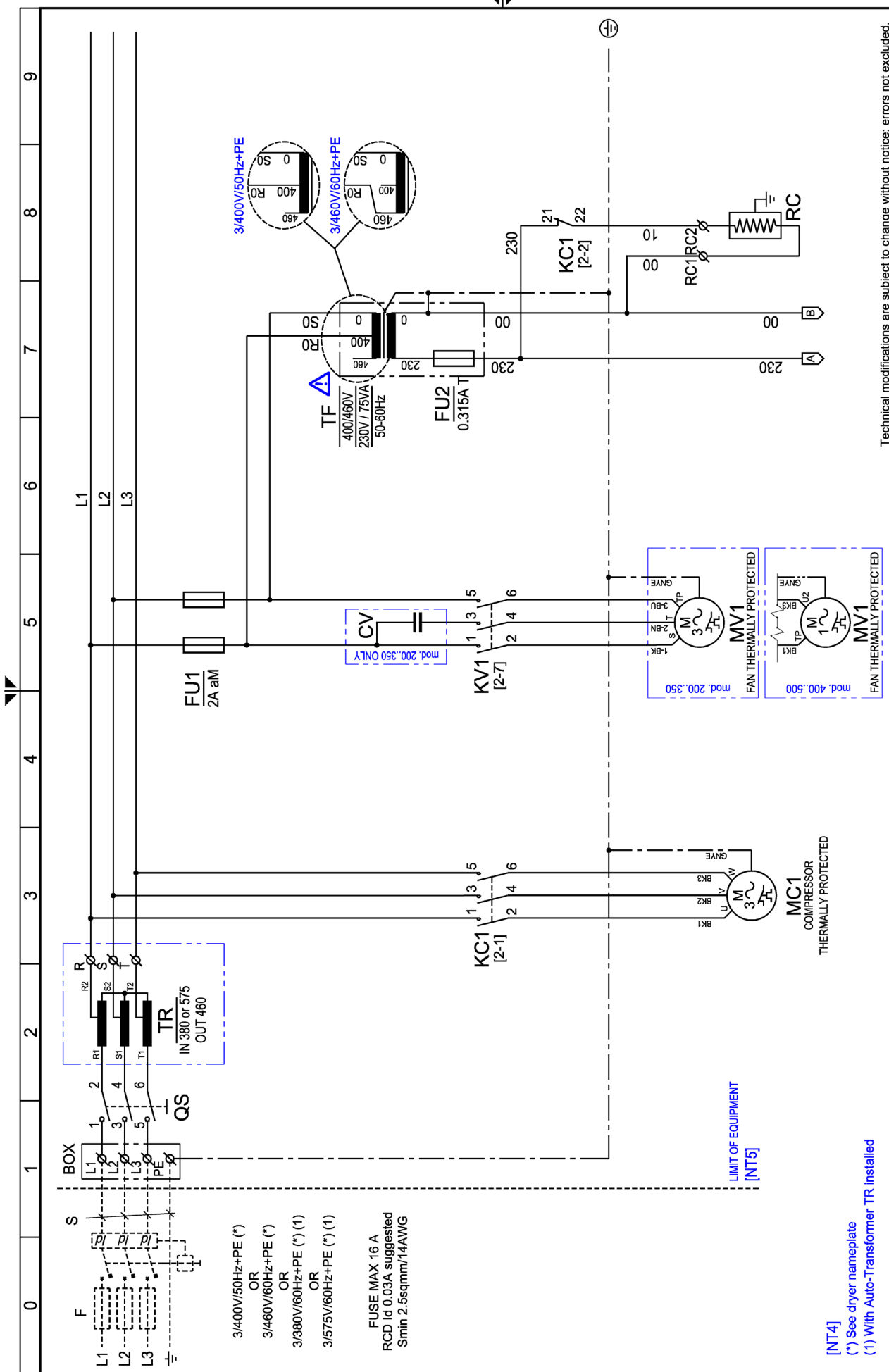

Drawing no. : **BKRACT5478QCDD017**
 Rev. **02**
 Note :

BEKO TECHNOLOGIES GMBH
<http://www.beko-technologies.com>



13.3.3 Electric diagram SPRPRC 200Z - 500Z 3phase Sheet 2/3

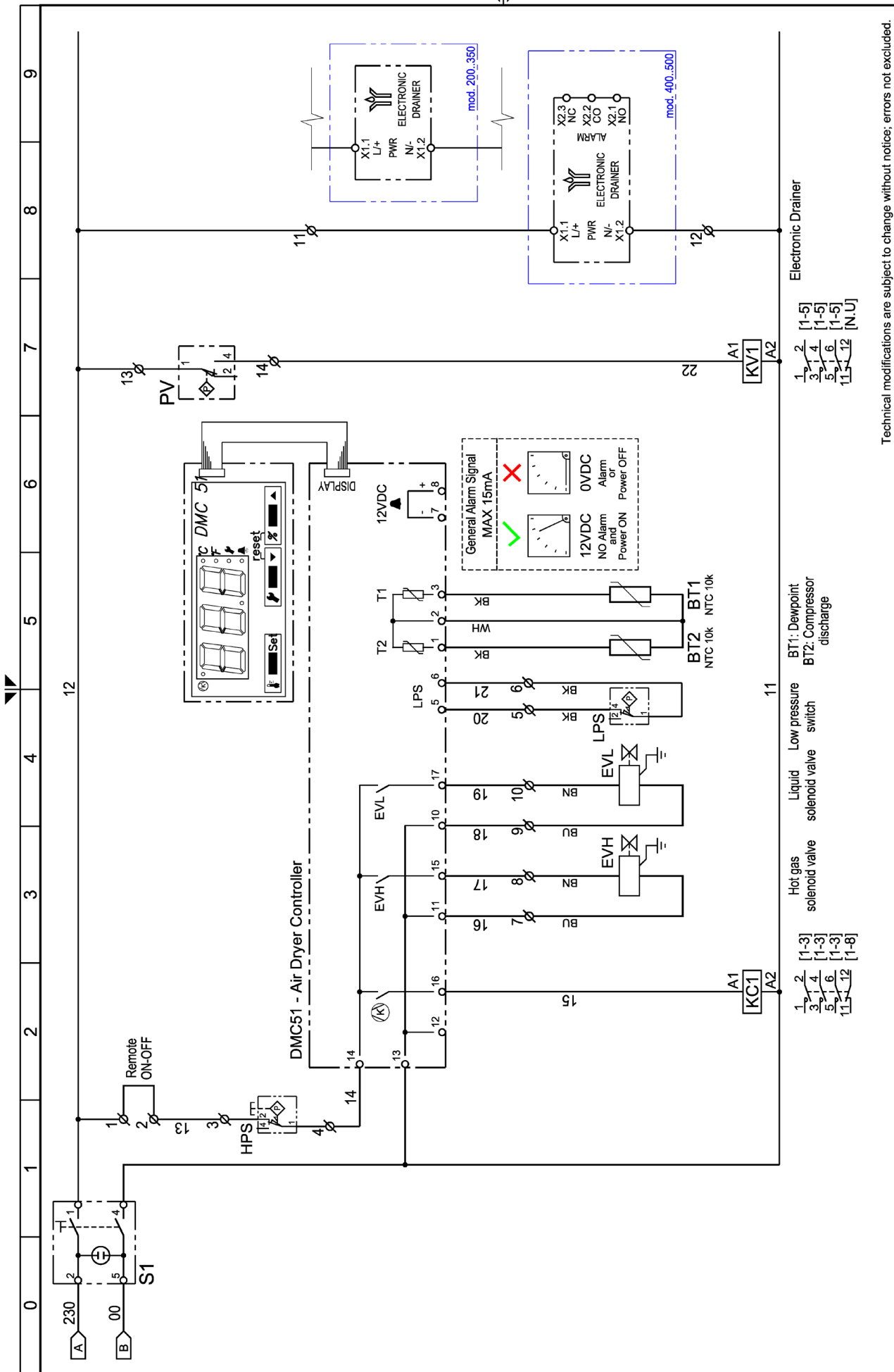

Technical modifications are subject to change without notice; errors not excluded.

Drawing no.: **BKRACT5478QCD017**
 Rev. **02**

Note: **Sheet 02 of 03**

13.3.4 Electric diagram SPRPRC 200Z - 500Z 3phase Sheet 3/3

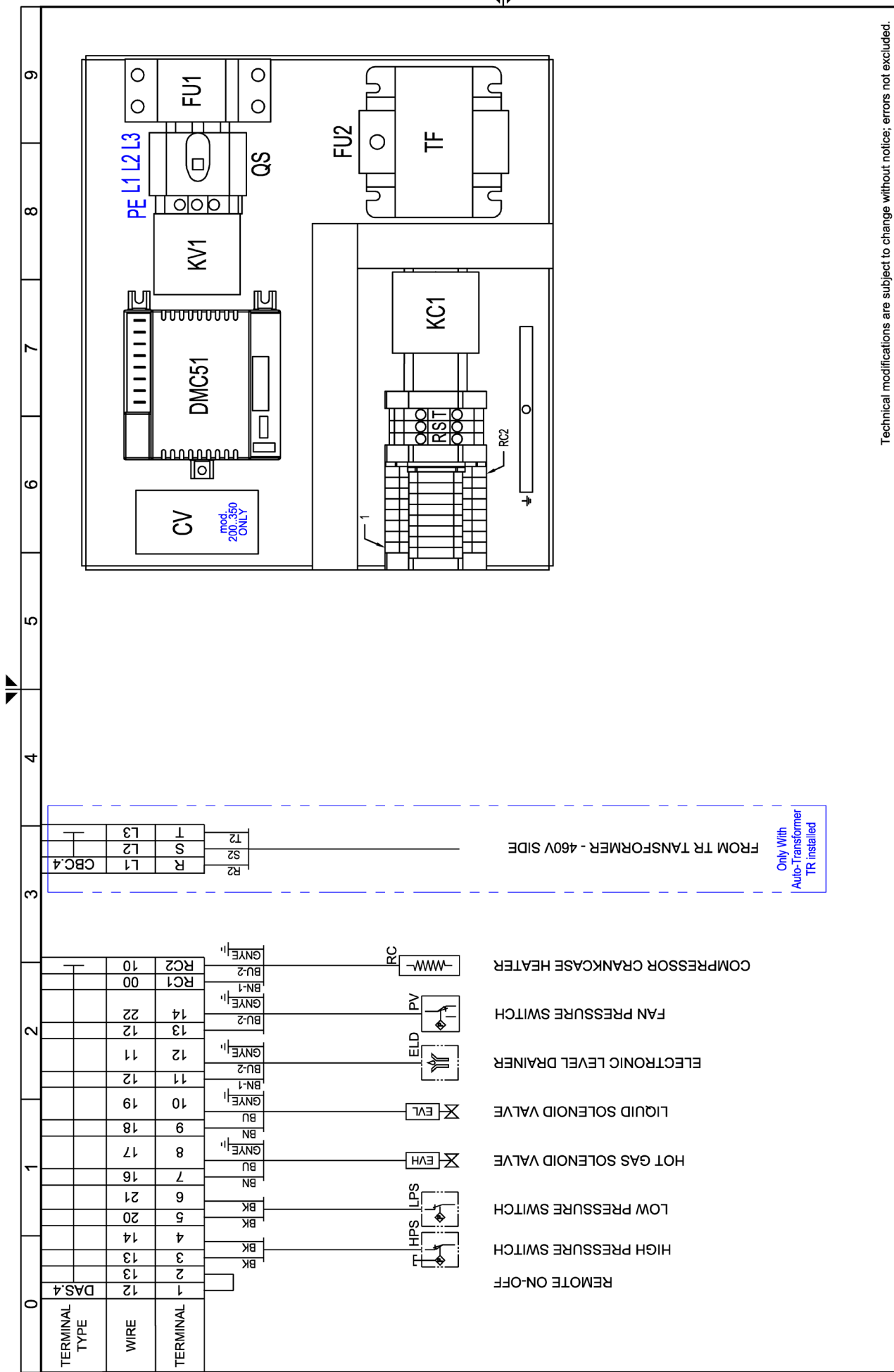

BEKO TECHNOLOGIES GMBH
<http://www.beko-technologies.com>



BLANK PAGE

BLANK PAGE

Original operating instructions in English.
Subject to technical changes / errors excepted.

SPRPRC_200Z_500Z_3ph_manual_en_12_2018

74MD0009C1-EN_00