



SP20+ SERIES

125 - 150 HP / INDUSTRIAL ELECTRIC COMPRESSOR

DEPENDABLE BY DESIGN



**SULLIVAN
PALATEK**



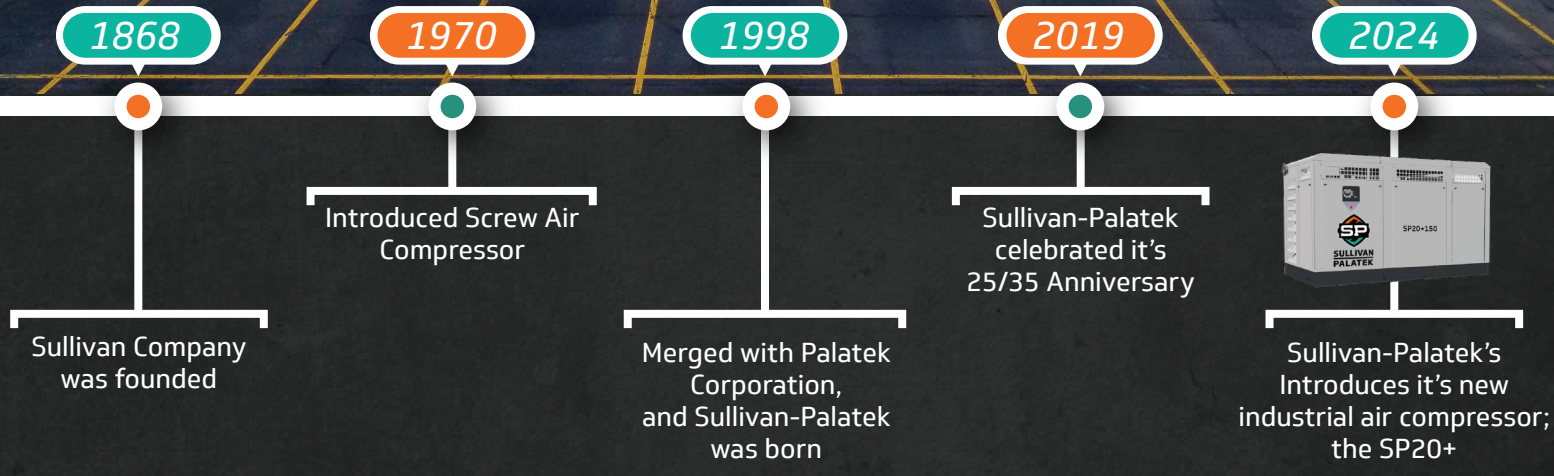

Sullivan-Palatek is committed to continuous improvement, in the compressed air industry, meeting the needs of customers, employees, suppliers, and shareholders in a world of rapid change.

Sullivan-Palatek, headquartered in Michigan City, has positioned itself as a leader in the realm of high-end industrial air compressors, setting a benchmark for reliability and a steadfast commitment to supporting American jobs through localized assembly. The core tenets of their value proposition encompass a comprehensive range of attributes, making them an industry standout.

At the heart of Sullivan-Palatek's offerings is an unwavering commitment to quality, ensuring that each air compressor is built to the highest standards. Their emphasis on efficiency underscores a dedication to optimizing performance, thereby delivering products that not only meet but exceed industry expectations. Moreover, customer support stands as a cornerstone, with a responsive and knowledgeable team ready to address any inquiries or issues, contributing to an overall seamless experience for clients.

Isentropic Efficiency:

Gauges how well a compressor transforms input power into compressed air, minimizing losses. In an ideal scenario, with no practical attainability, compression would occur without any inefficiencies like friction or heat dissipation. However, real-world processes involve unavoidable losses, diminishing efficiency. CAGI, backed by major compressor manufacturers, provides Compressor Data Sheets for performance comparison, now featuring Isentropic Efficiency as a helpful metric.

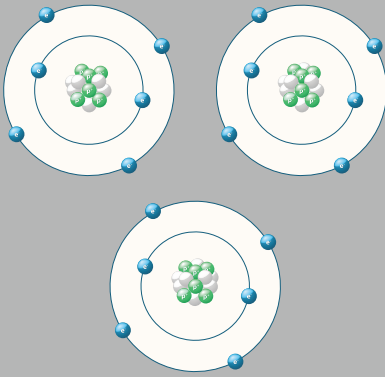

- Made in the USA
- Reduced energy consumption and more capacity
- Durable
- Precision machined and highly efficient rotor profile with tapered roller bearings
- Tight tolerances provide maximum efficiency.

204 mm Airend



Variable Speed vs. Fixed Speed

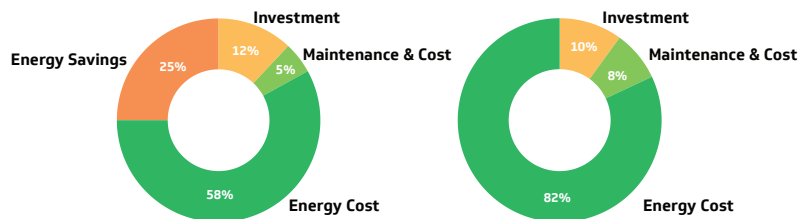

Using a variable frequency compressor can easily **save 25% energy** by using just the right amount of energy required to do the job and no more.

Sullivan-Palatek compressors with **Variable Frequency Drive (VFD)** dynamically adjust motor speed to match air demand, cutting power consumption. Key benefits include:

Energy Efficiency: VFD compressors save up to 25% compared to fixed-speed counterparts by aligning motor speed with required air output.

Lower Operating Costs: Diminished energy usage results in reduced operating expenses, especially in applications with varying air demand.

Environmental Advantages: Decreased greenhouse gas emissions contribute to sustainability goals, potentially reducing costs in high-energy regions.

Future Growth Flexibility: Output modulation based on demand enables adaptability for future expansion.

NEMA Premium Efficient, TEFC motor

- Totally Enclosed Fan Cooled with a true IP55 rating against dust and moisture
- All NEMA Premium ratings have a 1.25 Service Factor resulting in cooler operation and extended life of the motor
- Class F insulation (impregnation resin and magnet wire are class H)
- All Cast Iron Construction
- Solid feet for reduced vibration levels and impact absorption
- Optimized ventilation system for cooler operation and extended life
- Flange mounted for positive alignment
- Heavy-duty, slow-running 1800 rpm design



Sullivan-Palatek's Q1 Controller provides the user with expanded descriptions of all the operating controls. Twelve compressors are able to be synced up through this machine, and the Q1's optional web access monitoring makes it very user friendly.

Q1 Controller provides:

- Phase monitoring
- Programmable remote start/stop functionality
- Programmable power failure auto restart
- Running hours/hours loaded/unloaded
- Service timers and warnings, inhibits, alarms and shut-down protections
- Full system monitoring of all vital parameters
- Ethernet connectivity for web based monitoring (no subscription fees)
- MODBUS output for DCS visibility and control
- Multi-compressor sequencing and control
- Scheduling variable configurations

**EM Gauge option available*

Wye-delta starter housed in a NEMA 4 electrical enclosure - protection against moisture and wind driven rain



10 Micron Oil Filter with cellulose layered glass fiber substrate to provide more efficiency

- Easy and safe access to all service parts

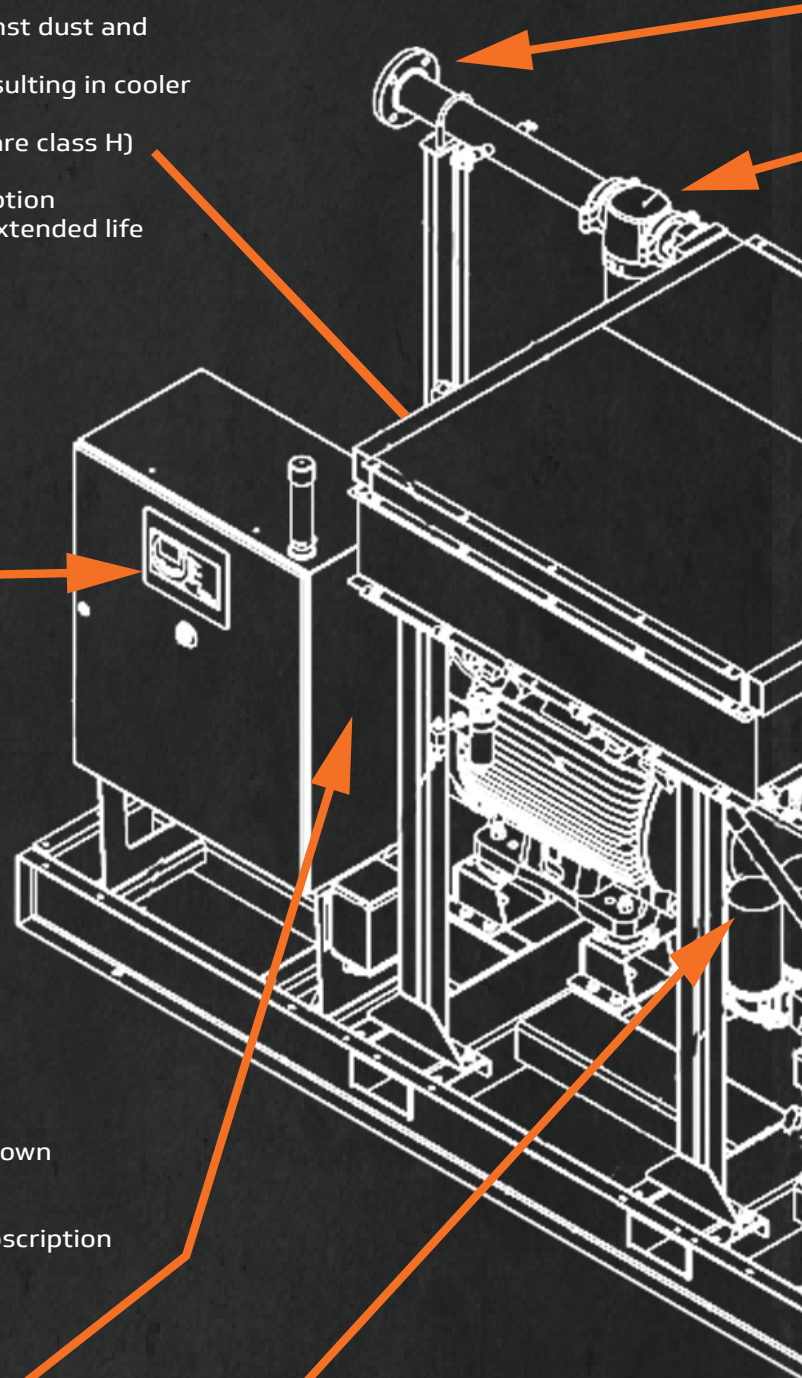

3 in. raised face 150 lbs. flange at the compressor's outlet to prevent stresses on plumbing and to aid in the installation

Condensate separator with timed auto-drain collects and automatically drains condensate

Cooler clean-outs for ease of cleaning

Corrosion Resistance piping



Heavy Duty Filter

- Easy to install, durable, and reliable
- Completely disposable - acceptable for normal trash pickup

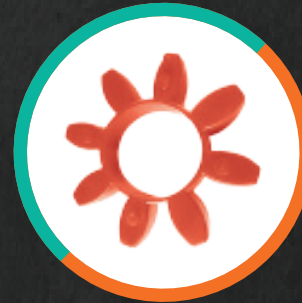

Coupling

- High Service Life
- Easy to service
- Excellent damping variations



Filled with PAL - EXTRA 44, a fully synthetic premium lubricant formulated to prevent varnish under higher temperatures and harsh conditions with an 8,000-hour extended drain interval



- Fully integrated, leak-free design utilizing corrosion resistant piping
- High-performance elastomeric seals ensure consistent, leak-free connections
- Vibration isolation system and metal-flex hoses enhance compressor lifespan and minimize noise
- Corrosion resistant air piping reduces downstream contamination for cleaner operation

Optimized Air-Oil separators have less restriction and reduce fluid carryover to less than 3 ppm with an 8,000-hour maintenance frequency



- **High-Efficiency Separation Element:** advanced filtration technology
- **Low Pressure Drop:** maintain the energy efficiency of the compressor
- **Quality Construction Materials:** prevents corrosion and wear

Optional Variable Frequency Drive | NEMA 1



Options

- Winterization protection
- Enclosure with easy-to-remove panels for service
- Solid state drive starter (SSRV)



Sullivan-Palatek ensures the dependability of their air compressors through an industry-leading warranty, offering benefits such as confidence in product quality, peace of mind with extended coverage, and robust customer support. Warranty options include:

Standard Warranty: One-year package and two year airend warranty with recommended OEM parts and lubricants.

Platinum Warranty: One-year package warranty with a five-year major components warranty, covering motor, airend, drive coupling, coolers, sump tank, and VFD drive. Includes reasonable freight and labor for repairs. OEM parts and lubricants required.

Platinum Plus Warranty: Extends airend warranty to ten years, unlimited hours, with required OEM parts and lubricants.

These warranty programs underscore the company's commitment to providing reliable compressed air, crucial for various industries.

*Refer to our full written warranty statement for additional details on coverage and user obligations.

Choosing Sullivan-Palatek PAL-Parts for air compressors is a wise investment, especially for critical equipment.

Benefits include:

Quality Assurance: PAL-Parts meet the same quality standards as original components.

Exact Fit: Designed for seamless integration, PAL-Parts facilitate efficient installations, minimizing downtime.

Warranty Preservation: PAL-Parts often maintain equipment warranties.

Consistent Performance: PAL-Parts ensure ongoing optimal performance, avoiding variables from non-PAL alternatives.

Opt for PAL-Parts to ensure longevity and ROI. Follow the manufacturer's maintenance schedule and consult your authorized distributor for optimal performance and service.

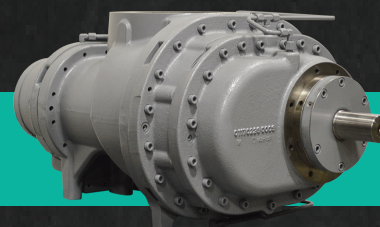

Sullivan-Palatek ensures your rotary screw compressor's longevity with advanced synthetic lubricants tailored to diverse compressed air system conditions. Our formulas address high ambient temperatures, high-pressure settings, and environments with acidic airborne elements. For applications requiring environmentally sensitive air contact, we use FDA-approved ingredients exceeding federal standards.

Pal-EXTRA 44: Custom-formulated polyolester (POE) 100% synthetic lubricant for low deposits in high temperatures and resistance to acidic intake air. 8000-hour service life.

Optional

Palasyn 45: Polyalphaolefin PAO synthetic blend for enhanced performance beyond conventional oils. 8000-hour service life.*

Pallube 32p: 100% synthetic lubricant with polyalkylene glycol (PAG) and pentaerythritol esters for improved cooling under high temperatures. 8000-hour service life.*

Food Grade 32 LL: Custom-blended polyalphaolefin (PAO) with FDA-approved ingredients for incidental food contact. 4000-hour service life.*

**Oil life may vary based on environmental conditions and compressor short cycling*

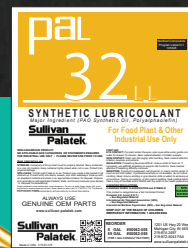

Rely on Sullivan-Palatek's authorized independent distributors for complete system and service support, including air treatment. Our network provides customer service, technical support, and professional air audits, offering expert advice on compressed air solutions and skilled routine maintenance by factory-trained personnel.



Key Advantages

- **Efficiency:** State-of-the-art screw elements, optimized gear drives, and integrated VFD reduce energy use while maintaining performance.
- **Reliability:** High-quality components withstand extreme conditions, ensuring longevity.
- **Ease of Use:** Smart controllers, modular designs, and service-friendly features enhance usability and reduce operational downtime.
- **Customizability:** Diverse optional features cater to specific industry requirements, from low to high ambient settings.

Technical Data

SP20+ Fix Speed			SP20+ Variable Frequency Drive (VFD)		
Model	SP20+125	SP20+150	Model	SP20+125	SP20+150
Horsepower	125	150	Horsepower	125	150
*acfm @ 100 psig L	644	747	*acfm @ 100 psig L	-	760
*acfm @ 125 psig	572	707	*acfm @ 125 psig	-	705
*acfm @ 150 psig H	510	628	*acfm @ 150 psig H	-	633
Dimensions Inches L x W x H					
Base Open			117 x 62 x 71		
Base Enclosed			117 x 62 x 72		
Weight lbs					
Base Open					
Base Enclosed					



CAGI Data Sheet

- TEFC Premium Efficient electric motor
- Wye-Delta starter
- Phase monitor
- Flexible vibration dampers
- Structural skid with no need for foundations
- PalExtra 44 fluid 8000h
- NEMA 4

Options

- SSRV
- Gauge electro-mechanical starters and controls



Sullivan-Palatek, Inc.

1201 West US Highway 20
Michigan City, IN 46360



219.874.2497

sullivan-palatek.com

info@palatek.com

